



The LARGEST in Vision Lighting  
Est. 1999



Online Product Catalog Price List

Pricing effective January 2026

<u>Ordering Information</u>	<u>2</u>
<u>Warranty</u>	<u>3</u>
<u>Back Lights (IP50)</u>	<u>4</u>
<u>Diffused Axial Lights (IP50)</u>	<u>19</u>
<u>Multi-Channel Dome Lights (IP50)</u>	<u>22</u>
<u>Dome Lights (IP50)</u>	<u>29</u>
<u>Linear “Bright Field” Lights (IP50)</u>	<u>32</u>
<u>Oxy (Flat Dome) Lights (IP50)</u>	<u>50</u>
<u>Ring “Bright Field” Lights (IP50)</u>	<u>52</u>
<u>Spot Lights (IP50)</u>	<u>62</u>
<u>Washdown Lights (IP68)</u>	<u>68</u>
<u>Controllers/Drivers and Cables (IP50)</u>	<u>76</u>
<u>Index</u>	<u>84</u>

**Ordering Information**

Order specification examples are shown throughout the price book at the top of each page. Be sure to follow the order sequence carefully to ensure complete and accurate order specification.

After placing an order, Spectrum Illumination will send an order acknowledgement.

**Send orders to:**  
orders@si-lights.com

Please review information such as ship date, ship address, and items ordered for accuracy.

**Placing an Order**

For accurate order processing on faxed orders, please type your order or use legible handwriting, and be sure to include the following information:

1. A complete "sold to" address with correct Zip code.
2. A complete "ship to" address with correct Zip code.
3. A purchase order number. (The order is issued to Spectrum Illumination, Montague, Michigan.)
4. A signature or name of person authorizing the purchase order.
5. A contact name, phone number and email address at your company.
6. An actual calendar date for the requested delivery date (not ASAP).
7. Line items that are complete, which means all catalog numbers and descriptions, options listed for each product selected. Be sure to make a pick for all available options. Also, combine identical items and specify total quantity unless using special marking or tagging. (Refer to the price book for ordering options.)

8. Special products referenced by their control numbers as well as their descriptions.

9. Line items that include price per unit, as well as extended totals.

10. A total dollar amount for the purchase order.

11. Any special shipping requirements clearly noted; i.e., "call before delivery."

By placing your orders correctly and completely the first time around, your order will be processed and scheduled without delay (subject to credit approval).

**Lead-Times**

Spectrum Illumination has a standard lead time of two (2) weeks. However, some items may take longer as they may be a specialty and therefore made to order.

**Note: Shipping lead-times are subject to product availability due to order size. For exact lead-times on your order contact Spectrum Illumination Customer Service.**

**Product Questions, Quotes & Order Placement.**

Hours: Monday-Friday 9am to 5pm EST

Customer Service Representative  
Hours: Monday-Friday 9am to 5pm EST

Phone: 1-231-894-4590  
Fax: 1-231-894-4582

e-mail: customerservice@si-lights.com

For more information on Order Placement, Confirmation and Lead-Times, see the Terms & Policies section in this book.

**1. Prices**

Spectrum Illumination reserves the right to change prices without notice. Firm quotations are available upon request and will be honored for a period of fifteen(15) days.

**2. Confirmation**

Upon receiving an order, Spectrum Illumination will send an order acknowledgment with exact pricing information and scheduled shipping date.

Customer is responsible for checking acknowledgments to ensure that the order is correct. Order will be processed as acknowledged.

**3. Lead Times**

Spectrum Illumination reserves the right to alter lead times as demand for products fluctuate. Stated lead times begin after an order is entered and scheduled. Shipments are subject to product availability. Special products and larger orders may extend leadtimes. Please contact customer service for exact lead times.

Spectrum Illumination has a standard lead time of two (2) weeks. However, some items may take longer as they may be a specialty and therefore made to order.

**4. Past Due Accounts**

Past Due Accounts will be charged 1.5% per month. This is an annual rate of 18% or the highest legal rate on the unpaid balance. The purchaser agrees to pay all collection agency fees, court costs, and/or reasonable attorney fees incurred by Spectrum Illumination in the collection of past due balances.

**LIMITED WARRANTY**

Every Spectrum Illumination, Inc. product is thoroughly inspected and tested before leaving the factory products purchased on or after September 1, 2013 (**excluding wash down light heads**) are warranted to be free of defects in workmanship and materials for a period of **10 Years\* (upon registration)** from the original date of purchase. Non-registered products default to **6 Years**. Should a defect develop during this period, return the complete product, freight prepaid, to one of Spectrum Illumination's distributors. The distributor will need to call for an RMA for repair before returning the product to Spectrum Illumination, Inc. Spectrum Illumination, Inc. will inspect the unit, and if a defect is found will, at our option, repair or replace the product without charge. Spectrum Illumination, Inc. disclaims liability for any implied warranties, including implied warranties of "merchantability" and "fitness for a specific purpose." **Register your warranty [www.spectrumillumination.com/warranty-registration/](http://www.spectrumillumination.com/warranty-registration/).**

Washdown light heads and standard products purchased before September 1, 2013 are covered for a period of **3 Years** from the original date of purchase. Wash down light heads are enclosed in stainless steel enclosures that do not dissipate heat away from the LED's as well as standard products. All requirements for return are stipulated in the previous paragraph. **Register your warranty [www.spectrumillumination.com/warranty-registration/](http://www.spectrumillumination.com/warranty-registration/).**

Spectrum Illumination, Inc. cannot be held responsible for the unauthorized or inappropriate use of our products. Products that include a driver will not be covered under this warranty if the driver was not used. Spectrum Illumination, Inc. will not cover products that have been determined to have run on third party strobe or LED controllers. **Register your warranty [www.spectrumillumination.com/warranty-registration/](http://www.spectrumillumination.com/warranty-registration/).**

**NO LIABILITY FOR CONSEQUENTIAL DAMAGES.**

In no event shall Spectrum Illumination, Inc. be liable for consequential, special, incidental, extra cost, expenses, losses, loss of profits or indirect damages of any kind arising from the sale or use of products.

**This warranty supersedes all previously printed Spectrum Illumination warranties.**

10 Year Registered Products	6 Year Non - Registered Products	3 Year
Back Lights	Back Lights	Washdown Lights
Diffused Lights	Diffused Lights	
Dome Lights	Dome Lights	
Linear Lights	Linear Lights	
Oxy Lights	Oxy Lights	
Ring Lights	Ring Lights	
Spot Lights	Spot Lights	. Standard
Controllers	Controllers	

\*10-Year warranty on registered products, 6-Year on non-registered products and 3-year on washdown lights.

Register your warranty [www.spectrumillumination.com/warranty-registration/](http://www.spectrumillumination.com/warranty-registration/) or scan QR code



## Back Lights

Standard-Series Back Lights - No Driver Required	6-13
Monster-Series Back Lights - External Driver Required	14-16
RGBW-Series Back Lights - COMING SOON!	17

## Standard-Series Back Lights

### Features:

- M12 connector for quick disconnect
- High speed built-in strobe
- 24VDC
- No driver/controller required
- Available in 4 colors and Infrared (IR)
- Available in 25+ sizes plus custom
- 10 Year Warranty\* - 100,000 hours

Backlights run directly on 24 VD and have strobe control. Backlights come with a standard 4 pin m12 connector. Spectrum Illumination Standard Series Lights are engineered to provide up to 100,000 hours of trouble free operation.

### To Order, Specify;

1 Base Part Number	<b>SBL22</b>
	<b>\$510</b>
2 Specify LED Color	<b>470</b>
	<b>+ \$15</b>
3 Specify Diffuser Type	<b>WD</b>
	<b>+ \$0</b>
4 Specify Cable Option	<b>SC4</b>
	<b>+ \$0</b>

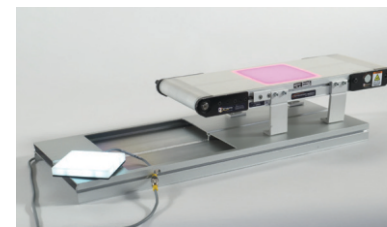
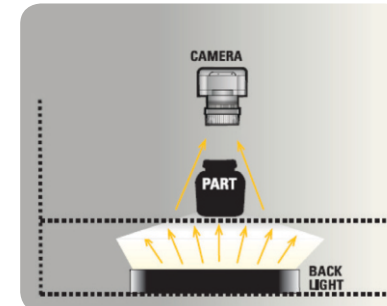

All Spectrum Illumination's Standard Series Back Lights can be configured for conveyor applications with the selection of the WDC diffuser option.

Shown with WDC Diffuser for conveyor applications



Shown with WD Diffuser

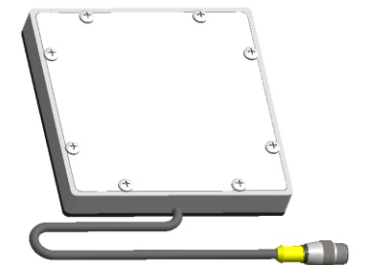

For cutout sizing visit [www.si-lights.com/product-type/back-lights/](http://www.si-lights.com/product-type/back-lights/)

### Color code for standard industrial cables:

- Brown +24 VDC
- Blue GND
- Black Strobe/Continuous line (+24 VDC)
- White NpN

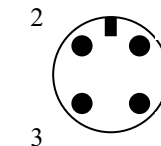

### CONNECTOR PINOUT:

- | Pin# | Signal                                  |
|------|---|
| 1    | +24VDC                                  |
| 2    | NPN <i>Must use a 4 or 5 wire cable</i> |
| 3    | GND                                     |
| 4    | Strobe/Continuous                       |

## Warning!!!

Use additional heat sink for backlight used in constant "on" mode. Mount aluminum back plate to an additional heat sinking material. No additional heat sink is needed for light in "strobe" mode.

## Standard-Series Back Lights

1 Base Part Number	List Price	2 LED Color	3 Diffuser Type	4 Cable Option
<b>SBL14</b> 1"x4" Back Light LED - Package Includes Light, and 4 Meter Cable	<b>\$510</b>	<b>470 + \$15</b> Blue	<b>WD + \$0</b> White Diffuser	<b>SC4 + \$0</b> Standard Cable 4 meter
		<b>530 *</b> Green	<b>CC + \$0</b> Clear Cover	<b>SC8 + \$50</b> Standard Cable 8 meter
<b>Standard</b> 		<b>660 + \$15</b> Red	<b>SD + \$0</b> Standard Diffuser	<b>SC15 + \$85</b> Standard Cable 15 meter
		<b>880 + \$20</b> Infrared	<b>TFD + \$25</b> Thin Film Diffuser	<b>SC30 *</b> Standard Cable 30 meter
<b>Conveyor</b> 		<b>WHI + \$0</b> White	<b>P + \$25</b> Polarizer	<b>SCHF4 + \$35</b> Standard High Flex Cable 4 meter
			<b>DD + \$25</b> Distortion Diffuser	<b>SCHF8 + \$60</b> Standard High Flex Cable 8 meter
			<b>LCF *</b> Light Collimating Film	<b>SCHF15 + \$160</b> Standard High Flex Cable 15 meter
			<b>WDC + \$0</b> White diffuser for conveyor	

Dimensions: W 2" L 5" H .85" Wgt .40lbs

(\*) Call for pricing

<b>SBL18</b> 1"x8" Back Light LED - Package Includes Light, and 4 Meter Cable	<b>\$545</b>	<b>470 + \$30</b> Blue	<b>WD + \$0</b> White Diffuser	<b>SC4 + \$0</b> Standard Cable 4 meter
		<b>530 *</b> Green	<b>CC + \$0</b> Clear Cover	<b>SC8 + \$50</b> Standard Cable 8 meter
<b>Standard</b> 		<b>660 + \$30</b> Red	<b>SD + \$0</b> Standard Diffuser	<b>SC15 + \$85</b> Standard Cable 15 meter
		<b>880 + \$40</b> Infrared	<b>TFD + \$25</b> Thin Film Diffuser	<b>SC30 *</b> Standard Cable 30 meter
<b>Conveyor</b> 		<b>WHI + \$0</b> White	<b>P + \$25</b> Polarizer	<b>SCHF4 + \$35</b> Standard High Flex Cable 4 meter
			<b>DD + \$25</b> Distortion Diffuser	<b>SCHF8 + \$60</b> Standard High Flex Cable 8 meter
			<b>LCF *</b> Light Collimating Film	<b>SCHF15 + \$160</b> Standard High Flex Cable 15 meter
			<b>WDC + \$0</b> White diffuser for conveyor	

Dimensions: W 2" L 9" H .85" Wgt .55lbs

(\*) Call for pricing

<b>SBL22</b> 2"x2" Back Light LED - Package Includes Light, and 4 Meter Cable	<b>\$510</b>	<b>470 + \$15</b> Blue	<b>WD + \$0</b> White Diffuser	<b>SC4 + \$0</b> Standard Cable 4 meter
		<b>530 *</b> Green	<b>CC + \$0</b> Clear Cover	<b>SC8 + \$50</b> Standard Cable 8 meter
<b>Standard</b> 		<b>660 + \$15</b> Red	<b>SD + \$0</b> Standard Diffuser	<b>SC15 + \$85</b> Standard Cable 15 meter
		<b>880 + \$20</b> Infrared	<b>TFD + \$25</b> Thin Film Diffuser	<b>SC30 *</b> Standard Cable 30 meter
<b>Conveyor</b> 		<b>WHI + \$0</b> White	<b>P + \$25</b> Polarizer	<b>SCHF4 + \$35</b> Standard High Flex Cable 4 meter
			<b>DD + \$25</b> Distortion Diffuser	<b>SCHF8 + \$60</b> Standard High Flex Cable 8 meter
			<b>LCF *</b> Light Collimating Film	<b>SCHF15 + \$160</b> Standard High Flex Cable 15 meter
			<b>WDC + \$0</b> White diffuser for conveyor	

Dimensions: W 3" L 3" H .85" Wgt .40lbs

(\*) Call for pricing

## Standard-Series Back Lights

1 Base Part Number	List Price	2 LED Color	3 Diffuser Type	4 Cable Option
<b>SBL24</b> 2"x4" Back Light LED - Package Includes Light, and 4 Meter Cable	<b>\$545</b>	<b>470 + \$30</b> Blue	<b>WD + \$0</b> White Diffuser	<b>SC4 + \$0</b> Standard Cable 4 meter
		<b>530 *</b> Green	<b>CC + \$0</b> Clear Cover	<b>SC8 + \$50</b> Standard Cable 8 meter
<b>Standard</b> 		<b>660 + \$30</b> Red	<b>SD + \$0</b> Standard Diffuser	<b>SC15 + \$85</b> Standard Cable 15 meter
		<b>880 + \$40</b> Infrared	<b>TFD + \$25</b> Thin Film Diffuser	<b>SC30 *</b> Standard Cable 30 meter
<b>Conveyor</b> 		<b>WHI + \$0</b> White	<b>P + \$25</b> Polarizer	<b>SCHF4 + \$35</b> Standard High Flex Cable 4 meter
			<b>DD + \$25</b> Distortion Diffuser	<b>SCHF8 + \$60</b> Standard High Flex Cable 8 meter
			<b>LCF *</b> Light Collimating Film	<b>SCHF15 + \$160</b> Standard High Flex Cable 15 meter
			<b>WDC + \$0</b> White diffuser for conveyor	

Dimensions: W 3" L 5" H .85" Wgt .55lbs

(\*) Call for pricing

<b>SBL26</b> 2"x6" Back Light LED - Package Includes Light, and 4 Meter Cable	<b>\$605</b>	<b>470 + \$45</b> Blue	<b>WD + \$0</b> White Diffuser	<b>SC4 + \$0</b> Standard Cable 4 meter
		<b>530 *</b> Green	<b>CC + \$0</b> Clear Cover	<b>SC8 + \$50</b> Standard Cable 8 meter
<b>Standard</b> 		<b>660 + \$45</b> Red	<b>SD + \$0</b> Standard Diffuser	<b>SC15 + \$85</b> Standard Cable 15 meter
		<b>880 + \$60</b> Infrared	<b>TFD + \$25</b> Thin Film Diffuser	<b>SC30 *</b> Standard Cable 30 meter
<b>Conveyor</b> 		<b>WHI + \$0</b> White	<b>P + \$25</b> Polarizer	<b>SCHF4 + \$35</b> Standard High Flex Cable 4 meter
			<b>DD + \$25</b> Distortion Diffuser	<b>SCHF8 + \$60</b> Standard High Flex Cable 8 meter
			<b>LCF *</b> Light Collimating Film	<b>SCHF15 + \$160</b> Standard High Flex Cable 15 meter
			<b>WDC + \$0</b> White diffuser for conveyor	

Dimensions: W 3" L 7" H .85" Wgt .73lbs

(\*) Call for pricing

<b>SBL210</b> 2"x10" Back Light LED - Package Includes Light, and 4 Meter Cable	<b>\$850</b>	<b>470 + \$75</b> Blue	<b>WD + \$0</b> White Diffuser	<b>SC4 + \$0</b> Standard Cable 4 meter
		<b>530 *</b> Green	<b>CC + \$0</b> Clear Cover	<b>SC8 + \$50</b> Standard Cable 8 meter
<b>Standard</b> 		<b>660 + \$75</b> Red	<b>SD + \$0</b> Standard Diffuser	<b>SC15 + \$85</b> Standard Cable 15 meter
		<b>880 + \$100</b> Infrared	<b>TFD + \$25</b> Thin Film Diffuser	<b>SC30 *</b> Standard Cable 30 meter
<b>Conveyor</b> 		<b>WHI + \$0</b> White	<b>P + \$30</b> Polarizer	<b>SCHF4 + \$35</b> Standard High Flex Cable 4 meter
			<b>DD + \$25</b> Distortion Diffuser	<b>SCHF8 + \$60</b> Standard High Flex Cable 8 meter
			<b>LCF *</b> Light Collimating Film	<b>SCHF15 + \$160</b> Standard High Flex Cable 15 meter
			<b>WDC + \$0</b> White diffuser for conveyor	

Dimensions: W 3" L 11" H .85" Wgt .80lbs

(\*) Call for pricing

## Standard-Series Back Lights

1 Base Part Number	List Price	2 LED Color	3 Diffuser Type	4 Cable Option
<b>SBL34</b> 3"x4" Back Light LED - Package Includes Light, and 4 Meter Cable	<b>\$605</b>	<b>470 + \$45</b> Blue <b>530 *</b> Green <b>660 + \$45</b> Red <b>880 + \$60</b> Infrared <b>WHI + \$0</b> White	<b>WD + \$0</b> White Diffuser <b>CC + \$0</b> Clear Cover <b>SD + \$0</b> Standard Diffuser <b>TFD + \$25</b> Thin Film Diffuser <b>P + \$25</b> Polarizer <b>DD + \$25</b> Distortion Diffuser <b>LCF *</b> Light Collimating Film <b>WDC + \$0</b> White diffuser for conveyor	<b>SC4 + \$0</b> Standard Cable 4 meter <b>SC8 + \$50</b> Standard Cable 8 meter <b>SC15 + \$85</b> Standard Cable 15 meter <b>SC30 *</b> Standard Cable 30 meter <b>SCHF4 + \$35</b> Standard High Flex Cable 4 meter <b>SCHF8 + \$60</b> Standard High Flex Cable 8 meter <b>SCHF15 + \$160</b> Standard High Flex Cable 15 meter
<b>Standard</b> 				
<b>Conveyor</b> 				

Dimensions: W 4" L 5" H .85" Wgt .68lbs

(\*) Call for pricing

<b>SBL36</b> 3"x6" Back Light LED - Package Includes Light, and 4 Meter Cable	<b>\$732.50</b>	<b>470 + \$67.50</b> Blue <b>530 *</b> Green <b>660 + \$67.50</b> Red <b>880 + \$90</b> Infrared <b>WHI + \$0</b> White	<b>WD + \$0</b> White Diffuser <b>CC + \$0</b> Clear Cover <b>SD + \$0</b> Standard Diffuser <b>TFD + \$25</b> Thin Film Diffuser <b>P + \$25</b> Polarizer <b>DD + \$25</b> Distortion Diffuser <b>LCF *</b> Light Collimating Film <b>WDC + \$0</b> White diffuser for conveyor	<b>SC4 + \$0</b> Standard Cable 4 meter <b>SC8 + \$50</b> Standard Cable 8 meter <b>SC15 + \$85</b> Standard Cable 15 meter <b>SC30 *</b> Standard Cable 30 meter <b>SCHF4 + \$35</b> Standard High Flex Cable 4 meter <b>SCHF8 + \$60</b> Standard High Flex Cable 8 meter <b>SCHF15 + \$160</b> Standard High Flex Cable 15 meter
<b>Standard</b> 				
<b>Conveyor</b> 				

Dimensions: W 4" L 7" H .85" Wgt .68lbs

(\*) Call for pricing

<b>SBL38</b> 3"x8" Back Light LED - Package Includes Light, and 4 Meter Cable	<b>\$810</b>	<b>470 + \$90</b> Blue <b>530 *</b> Green <b>660 + \$90</b> Red <b>880 + \$120</b> Infrared <b>WHI + \$0</b> White	<b>WD + \$0</b> White Diffuser <b>CC + \$0</b> Clear Cover <b>SD + \$0</b> Standard Diffuser <b>TFD + \$25</b> Thin Film Diffuser <b>P + \$35</b> Polarizer <b>DD + \$25</b> Distortion Diffuser <b>LCF *</b> Light Collimating Film <b>WDC + \$0</b> White diffuser for conveyor	<b>SC4 + \$0</b> Standard Cable 4 meter <b>SC8 + \$50</b> Standard Cable 8 meter <b>SC15 + \$85</b> Standard Cable 15 meter <b>SC30 *</b> Standard Cable 30 meter <b>SCHF4 + \$35</b> Standard High Flex Cable 4 meter <b>SCHF8 + \$60</b> Standard High Flex Cable 8 meter <b>SCHF15 + \$160</b> Standard High Flex Cable 15 meter
<b>Standard</b> 				
<b>Conveyor</b> 				

Dimensions: W 4" L 9" H .85" Wgt 1.05lbs

(\*) Call for pricing

## Standard-Series Back Lights

1 Base Part Number	List Price	2 LED Color	3 Diffuser Type	4 Cable Option
<b>SBL312</b> 3"x12" Back Light LED - Package Includes Light, and 4 Meter Cable	<b>\$1,175</b>	<b>470 + \$125</b> Blue <b>530 *</b> Green <b>660 + \$125</b> Red <b>880 + \$180</b> Infrared <b>WHI + \$0</b> White	<b>WD + \$0</b> White Diffuser <b>CC + \$0</b> Clear Cover <b>SD + \$0</b> Standard Diffuser <b>TFD + \$25</b> Thin Film Diffuser <b>P + \$40</b> Polarizer <b>DD + \$25</b> Distortion Diffuser <b>LCF *</b> Light Collimating Film <b>WDC + \$0</b> White diffuser for conveyor	<b>SC4 + \$0</b> Standard Cable 4 meter <b>SC8 + \$50</b> Standard Cable 8 meter <b>SC15 + \$85</b> Standard Cable 15 meter <b>SC30 *</b> Standard Cable 30 meter <b>SCHF4 + \$35</b> Standard High Flex Cable 4 meter <b>SCHF8 + \$60</b> Standard High Flex Cable 8 meter <b>SCHF15 + \$160</b> Standard High Flex Cable 15 meter
<b>Standard</b> 				
<b>Conveyor</b> 				

Dimensions: W 4" L 13" H .85" Wgt 1.58lbs

(\*) Call for pricing

<b>SBL44</b> 4"x4" Back Light LED - Package Includes Light, and 4 Meter Cable	<b>\$665</b>	<b>470 + \$60</b> Blue <b>530 *</b> Green <b>660 + \$60</b> Red <b>880 + \$90</b> Infrared <b>WHI + \$0</b> White	<b>WD + \$0</b> White Diffuser <b>CC + \$0</b> Clear Cover <b>SD + \$0</b> Standard Diffuser <b>TFD + \$25</b> Thin Film Diffuser <b>P + \$25</b> Polarizer <b>DD + \$25</b> Distortion Diffuser <b>LCF *</b> Light Collimating Film <b>WDC + \$0</b> White diffuser for conveyor	<b>SC4 + \$0</b> Standard Cable 4 meter <b>SC8 + \$50</b> Standard Cable 8 meter <b>SC15 + \$85</b> Standard Cable 15 meter <b>SC30 *</b> Standard Cable 30 meter <b>SCHF4 + \$35</b> Standard High Flex Cable 4 meter <b>SCHF8 + \$60</b> Standard High Flex Cable 8 meter <b>SCHF15 + \$160</b> Standard High Flex Cable 15 meter
<b>Standard</b> 				
<b>Conveyor</b> 				

Dimensions: W 5" L 5" H .85" Wgt .80lbs







(\*) Call for pricing

<b>SBL46</b> 4"x6" Back Light LED - Package Includes Light, and 4 Meter Cable	<b>\$835</b>	<b>470 + \$90</b> Blue <b>530 *</b> Green <b>660 + \$90</b> Red <b>880 + \$120</b> Infrared <b>WHI + \$0</b> White	<b>WD + \$0</b> White Diffuser <b>CC + \$0</b> Clear Cover <b>SD + \$0</b> Standard Diffuser <b>TFD + \$25</b> Thin Film Diffuser <b>P + \$35</b> Polarizer <b>DD + \$25</b> Distortion Diffuser <b>LCF *</b> Light Collimating Film <b>WDC + \$0</b> White diffuser for conveyor	<b>SC4 + \$0</b> Standard Cable 4 meter <b>SC8 + \$50</b> Standard Cable 8 meter <b>SC15 + \$85</b> Standard Cable 15 meter <b>SC30 *</b> Standard Cable 30 meter <b>SCHF4 + \$35</b> Standard High Flex Cable 4 meter <b>SCHF8 + \$60</b> Standard High Flex Cable 8 meter <b>SCHF15 + \$160</b> Standard High Flex Cable 15 meter
<b>Standard</b> 				
<b>Conveyor</b> 				

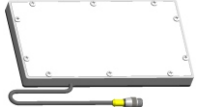





Dimensions: W 5" L 7" H .85" Wgt 1.05lbs

(\*) Call for pricing

## Standard-Series Back Lights

1 Base Part Number	List Price	2 LED Color	3 Diffuser Type	4 Cable Option
<b>SBL48</b> 4"x8" Back Light LED - Package Includes Light, and 4 Meter Cable	<b>\$980</b>	<b>470 + \$120</b> Blue	<b>WD + \$0</b> White Diffuser	<b>SC4 + \$0</b> Standard Cable 4 meter
		<b>530 *</b> Green	<b>CC + \$0</b> Clear Cover	<b>SC8 + \$50</b> Standard Cable 8 meter
<b>Standard</b> 		<b>660 + \$120</b> Red	<b>SD + \$0</b> Standard Diffuser	<b>SC15 + \$85</b> Standard Cable 15 meter
		<b>880 + \$160</b> Infrared	<b>TFD + \$25</b> Thin Film Diffuser	<b>SC30 *</b> Standard Cable 30 meter
<b>Conveyor</b> 		<b>WHI + \$0</b> White	<b>P + \$40</b> Polarizer	<b>SCHF4 + \$35</b> Standard High Flex Cable 4 meter
			<b>DD + \$25</b> Distortion Diffuser	<b>SCHF8 + \$60</b> Standard High Flex Cable 8 meter
			<b>LCF *</b> Light Collimating Film	<b>SCHF15 + \$160</b> Standard High Flex Cable 15 meter
			<b>WDC + \$0</b> White diffuser for conveyor	
Dimensions: W 5" L 9" H .85" Wgt 1.36lbs (*) Call for pricing				
<b>SBL414</b> 4"x14" Back Light LED - Package Includes Light, and 4 Meter Cable	<b>\$1490</b>	<b>470 + \$210</b> Blue	<b>WD + \$0</b> White Diffuser	<b>SC4 + \$0</b> Standard Cable 4 meter
		<b>530 *</b> Green	<b>CC + \$0</b> Clear Cover	<b>SC8 + \$50</b> Standard Cable 8 meter
<b>Standard</b> 		<b>660 + \$210</b> Red	<b>SD + \$0</b> Standard Diffuser	<b>SC15 + \$85</b> Standard Cable 15 meter
		<b>880 + \$280</b> Infrared	<b>TFD + \$25</b> Thin Film Diffuser	<b>SC30 *</b> Standard Cable 30 meter
<b>Conveyor</b> 		<b>WHI + \$0</b> White	<b>P + \$75</b> Polarizer	<b>SCHF4 + \$35</b> Standard High Flex Cable 4 meter
			<b>DD + \$25</b> Distortion Diffuser	<b>SCHF8 + \$60</b> Standard High Flex Cable 8 meter
			<b>LCF *</b> Light Collimating Film	<b>SCHF15 + \$160</b> Standard High Flex Cable 15 meter
			<b>WDC + \$0</b> White diffuser for conveyor	
Dimensions: W 4" L 15" H .85" Wgt .lbs (*) Call for pricing				
<b>SBL56</b> 5"x6" Back Light LED - Package Includes Light, and 4 Meter Cable	<b>\$962.50</b>	<b>470 + \$112.50</b> Blue	<b>WD + \$0</b> White Diffuser	<b>SC4 + \$0</b> Standard Cable 4 meter
		<b>530 *</b> Green	<b>CC + \$0</b> Clear Cover	<b>SC8 + \$50</b> Standard Cable 8 meter
<b>Standard</b> 		<b>660 + \$112.50</b> Red	<b>SD + \$0</b> Standard Diffuser	<b>SC15 + \$85</b> Standard Cable 15 meter
		<b>880 + \$162.50</b> Infrared	<b>TFD + \$25</b> Thin Film Diffuser	<b>SC30 *</b> Standard Cable 30 meter
<b>Conveyor</b> 		<b>WHI + \$0</b> White	<b>P + \$35</b> Polarizer	<b>SCHF4 + \$35</b> Standard High Flex Cable 4 meter
			<b>DD + \$25</b> Distortion Diffuser	<b>SCHF8 + \$60</b> Standard High Flex Cable 8 meter
			<b>LCF *</b> Light Collimating Film	<b>SCHF15 + \$160</b> Standard High Flex Cable 15 meter
			<b>WDC + \$0</b> White diffuser for conveyor	
Dimensions: W 6" L 7" H .85" Wgt 1.3 lbs (*) Call for pricing				

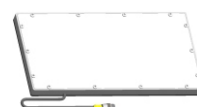
## Standard-Series Back Lights

1 Base Part Number	List Price	2 LED Color	3 Diffuser Type	4 Cable Option
<b>SBL66</b> 6"x6" Back Light LED - Package Includes Light, and 4 Meter Cable	<b>\$1,065</b>	<b>470 + \$135</b> Blue	<b>WD + \$0</b> White Diffuser	<b>SC4 + \$0</b> Standard Cable 4 meter
		<b>530 *</b> Green	<b>CC + \$0</b> Clear Cover	<b>SC8 + \$50</b> Standard Cable 8 meter
<b>Standard</b> 		<b>660 + \$135</b> Red	<b>SD + \$0</b> Standard Diffuser	<b>SC15 + \$85</b> Standard Cable 15 meter
		<b>880 + \$180</b> Infrared	<b>TFD + \$25</b> Thin Film Diffuser	<b>SC30 *</b> Standard Cable 30 meter
<b>Conveyor</b> 		<b>WHI + \$0</b> White	<b>P + \$45</b> Polarizer	<b>SCHF4 + \$35</b> Standard High Flex Cable 4 meter
			<b>DD + \$25</b> Distortion Diffuser	<b>SCHF8 + \$60</b> Standard High Flex Cable 8 meter
			<b>LCF *</b> Light Collimating Film	<b>SCHF15 + \$160</b> Standard High Flex Cable 15 meter
			<b>WDC + \$0</b> White diffuser for conveyor	
Dimensions: W 7" L 7" H .85" Wgt 1.58lbs (*) Call for pricing				
<b>SBL68</b> 6"x8" Back Light LED - Package Includes Light, and 4 Meter Cable	<b>\$1320</b>	<b>470 + \$180</b> Blue	<b>WD + \$0</b> White Diffuser	<b>SC4 + \$0</b> Standard Cable 4 meter
		<b>530 *</b> Green	<b>CC + \$0</b> Clear Cover	<b>SC8 + \$50</b> Standard Cable 8 meter
<b>Standard</b> 		<b>660 + \$180</b> Red	<b>SD + \$0</b> Standard Diffuser	<b>SC15 + \$85</b> Standard Cable 15 meter
		<b>880 + \$240</b> Infrared	<b>TFD + \$25</b> Thin Film Diffuser	<b>SC30 *</b> Standard Cable 30 meter
<b>Conveyor</b> 		<b>WHI + \$0</b> White	<b>P + \$60</b> Polarizer	<b>SCHF4 + \$35</b> Standard High Flex Cable 4 meter
			<b>DD + \$25</b> Distortion Diffuser	<b>SCHF8 + \$60</b> Standard High Flex Cable 8 meter
			<b>LCF *</b> Light Collimating Film	<b>SCHF15 + \$160</b> Standard High Flex Cable 15 meter
			<b>WDC + \$0</b> White diffuser for conveyor	
Dimensions: W 7" L 9" H .85" Wgt 1.75lbs (*) Call for pricing				
<b>SBL610</b> 6"x10" Back Light LED - Package Includes Light, and 4 Meter Cable	<b>\$1675</b>	<b>470 + \$225</b> Blue	<b>WD + \$0</b> White Diffuser	<b>SC4 + \$0</b> Standard Cable 4 meter
		<b>530 *</b> Green	<b>CC + \$0</b> Clear Cover	<b>SC8 + \$50</b> Standard Cable 8 meter
<b>Standard</b> 		<b>660 + \$225</b> Red	<b>SD + \$0</b> Standard Diffuser	<b>SC15 + \$85</b> Standard Cable 15 meter
		<b>880 + \$300</b> Infrared	<b>TFD + \$25</b> Thin Film Diffuser	<b>SC30 *</b> Standard Cable 30 meter
<b>Conveyor</b> 		<b>WHI + \$0</b> White	<b>P + \$75</b> Polarizer	<b>SCHF4 + \$35</b> Standard High Flex Cable 4 meter
			<b>DD + \$25</b> Distortion Diffuser	<b>SCHF8 + \$60</b> Standard High Flex Cable 8 meter
			<b>LCF *</b> Light Collimating Film	<b>SCHF15 + \$160</b> Standard High Flex Cable 15 meter
			<b>WDC + \$0</b> White diffuser for conveyor	
Dimensions: W 5" L 7" H .85" Wgt 1.05lbs (*) Call for pricing				

Back Lights  
Diffused Axial  
Dome Lights  
Linear Lights  
Oxy Lights  
Ring Lights  
Spot Lights  
Washdown Lights  
Controllers & Cables

Back Lights  
Diffused Axial  
Dome Lights  
Linear Lights  
Oxy Lights  
Ring Lights  
Spot Lights  
Washdown Lights  
Controllers & Cables

## Standard-Series Back Lights

1 Base Part Number	List Price	2 LED Color	3 Diffuser Type	4 Cable Option
<b>SBL612</b> 6"x12" Back Light LED- Package Includes Light, and 4 Meter Cable	<b>\$1830</b>	<b>470 + \$270</b> Blue <b>530 *</b> Green <b>660 + \$270</b> Red <b>880 + \$360</b> Infrared <b>WHI + \$0</b> White	<b>WD + \$0</b> White Diffuser <b>CC + \$0</b> Clear Cover <b>SD + \$0</b> Standard Diffuser <b>TFD + \$25</b> Thin Film Diffuser <b>P + \$85</b> Polarizer <b>DD + \$25</b> Distortion Diffuser <b>LCF *</b> Light Collimating Film <b>WDC + \$0</b> White diffuser for conveyor	<b>SC4 + \$0</b> Standard Cable 4 meter <b>SC8 + \$50</b> Standard Cable 8 meter <b>SC15 + \$85</b> Standard Cable 15 meter <b>SC30 *</b> Standard Cable 30 meter <b>SCHF4 + \$35</b> Standard High Flex Cable 4 meter <b>SCHF8 + \$60</b> Standard High Flex Cable 8 meter <b>SCHF15 + \$160</b> Standard High Flex Cable 15 meter
<b>Standard</b> 				
<b>Conveyor</b> 				
Dimensions: W 5" L 9" H .85" Wgt 1.36lbs (*) Call for pricing				

<b>SBL88</b> 8"x8" Back Light LED- Package Includes Light, and 4 Meter Cable	<b>\$1760</b>	<b>470 + \$240</b> Blue <b>530 *</b> Green <b>660 + \$240</b> Red <b>880 + \$320</b> Infrared <b>WHI + \$0</b> White	<b>WD + \$0</b> White Diffuser <b>CC + \$0</b> Clear Cover <b>SD + \$0</b> Standard Diffuser <b>TFD + \$25</b> Thin Film Diffuser <b>P + \$80</b> Polarizer <b>DD + \$25</b> Distortion Diffuser <b>LCF *</b> Light Collimating Film <b>WDC + \$0</b> White diffuser for conveyor	<b>SC4 + \$0</b> Standard Cable 4 meter <b>SC8 + \$50</b> Standard Cable 8 meter <b>SC15 + \$85</b> Standard Cable 15 meter <b>SC30 *</b> Standard Cable 30 meter <b>SCHF4 + \$35</b> Standard High Flex Cable 4 meter <b>SCHF8 + \$60</b> Standard High Flex Cable 8 meter <b>SCHF15 + \$160</b> Standard High Flex Cable 15 meter
<b>Standard</b> 				
<b>Conveyor</b> 				
Dimensions: W 4" L 15" H .85" Wgt .lbs (*) Call for pricing				

<b>SBL812</b> 8"x12" Back Light LED- Package Includes Light, and 4 Meter Cable	<b>\$2140</b>	<b>470 + \$360</b> Blue <b>530 *</b> Green <b>660 + \$360</b> Red <b>880 + \$480</b> Infrared <b>WHI + \$0</b> White	<b>WD + \$0</b> White Diffuser <b>CC + \$0</b> Clear Cover <b>SD + \$0</b> Standard Diffuser <b>TFD + \$25</b> Thin Film Diffuser <b>P + \$115</b> Polarizer <b>DD + \$25</b> Distortion Diffuser <b>LCF *</b> Light Collimating Film <b>WDC + \$0</b> White diffuser for conveyor	<b>SC4 + \$0</b> Standard Cable 4 meter <b>SC8 + \$50</b> Standard Cable 8 meter <b>SC15 + \$85</b> Standard Cable 15 meter <b>SC30 *</b> Standard Cable 30 meter <b>SCHF4 + \$35</b> Standard High Flex Cable 4 meter <b>SCHF8 + \$60</b> Standard High Flex Cable 8 meter <b>SCHF15 + \$160</b> Standard High Flex Cable 15 meter
<b>Standard</b> 				
<b>Conveyor</b> 				
Dimensions: W 6" L 7" H .85" Wgt 1.3 lbs (*) Call for pricing				

## Standard-Series Back Lights

1 Base Part Number	List Price	2 LED Color	3 Diffuser Type	4 Cable Option
<b>SBL1010</b> 10"x10" Back Light LED- Package Includes Light, and 4 Meter Cable	<b>\$2375</b>	<b>470 + \$375</b> Blue <b>530 *</b> Green <b>660 + \$375</b> Red <b>880 + \$500</b> Infrared <b>WHI + \$0</b> White	<b>WD + \$0</b> White Diffuser <b>CC + \$0</b> Clear Cover <b>SD + \$0</b> Standard Diffuser <b>TFD + \$25</b> Thin Film Diffuser <b>P + \$120</b> Polarizer <b>DD + \$25</b> Distortion Diffuser <b>LCF *</b> Light Collimating Film <b>WDC + \$0</b> White diffuser for conveyor	<b>SC4 + \$0</b> Standard Cable 4 meter <b>SC8 + \$50</b> Standard Cable 8 meter <b>SC15 + \$85</b> Standard Cable 15 meter <b>SC30 *</b> Standard Cable 30 meter <b>SCHF4 + \$35</b> Standard High Flex Cable 4 meter <b>SCHF8 + \$60</b> Standard High Flex Cable 8 meter <b>SCHF15 + \$160</b> Standard High Flex Cable 15 meter
<b>Standard</b> 				
<b>Conveyor</b> 				
Dimensions: W " L 7" H .85" Wgt 1.58lbs (*) Call for pricing				

<b>SBL1212</b> 12"x12" Back Light LED- Package Includes Light, and 4 Meter Cable	<b>\$2960</b>	<b>470 + \$540</b> Blue <b>530 *</b> Green <b>660 + \$540</b> Red <b>880 + \$720</b> Infrared <b>WHI + \$0</b> White	<b>WD + \$0</b> White Diffuser <b>CC + \$0</b> Clear Cover <b>SD + \$0</b> Standard Diffuser <b>TFD + \$25</b> Thin Film Diffuser <b>P + \$175</b> Polarizer <b>DD + \$25</b> Distortion Diffuser <b>LCF *</b> Light Collimating Film <b>WDC + \$0</b> White diffuser for conveyor	<b>SC4 + \$0</b> Standard Cable 4 meter <b>SC8 + \$50</b> Standard Cable 8 meter <b>SC15 + \$85</b> Standard Cable 15 meter <b>SC30 *</b> Standard Cable 30 meter <b>SCHF4 + \$35</b> Standard High Flex Cable 4 meter <b>SCHF8 + \$60</b> Standard High Flex Cable 8 meter <b>SCHF15 + \$160</b> Standard High Flex Cable 15 meter
<b>Standard</b> 				
<b>Conveyor</b> 				
Dimensions: W 7" L 9" H .85" Wgt 1.75lbs (*) Call for pricing				

Dimensions: W 7" L 9" H .85" Wgt 1.75lbs (*) Call for pricing				
---	--	--	--	--

## Monster-Series Back Lights

Features:

- External driver/controller included
- High speed strobe technology
- High power LED's (24 VDC)
- DIN rail mount driver/controller
- M12 connector for quick disconnect
- Available in 4 colors and Infrared
- 10 Year Warranty\* - 100,000 hours



**Caution –**

The supplied LDM adapter must be used for both continuous or strobe operations! Do not connect the fixture directly to 24 VDC! Operating the fixture without the supplied LDM adapter will result in premature LED failure, and will void the warranty.

To Order, Specify;

1 Base Part Number	2 LED Color	3 Diffuser Type	4 Driver Option	5 Cable Option
<b>MBL22</b>	<b>470</b>	<b>WD</b>	<b>A</b>	<b>MC4</b>
<b>\$750</b>	<b>\$0</b>	<b>\$0</b>	<b>\$85</b>	<b>\$0</b>

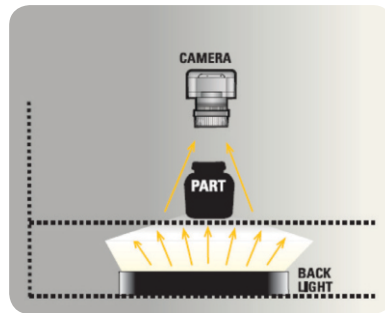

## Monster-Series Back Lights

1 Base Part Number	List Price	2 LED	3 Diffuser	4 Driver	5 Cable
<b>MBL22</b> 2" X 2" Back Light LED - Package Includes Light, LDM 350/2, and 4 Meter Cable	<b>\$750</b>	<b>470 + \$0</b> Blue <b>530 + \$0</b> Green <b>630 + \$0</b> Red <b>850 + \$20</b> Infrared <b>WHI + \$0</b> White	<b>WD + \$0</b> White Diffuser <b>CC + \$0</b> Clear Cover <b>SD + \$0</b> Standard Diffuser <b>TFD + \$25</b> Thin Film Diffuser <b>P + \$25</b> Polarizer <b>DD + \$25</b> Distortion Diffuser <b>LCF *</b> Light Collimating Film	<b>LDM350/2 + \$0</b> 350mA Driver <b>A + \$85</b> ALDM Driver <b>V + \$85</b> VLDM Driver <b>RV + \$100</b> RVLDM Driver	<b>MC4 + \$0</b> 4 meter <b>MC8 + \$20</b> 8 meter <b>MC15 + \$60</b> 15 meter <b>MC30 *</b> 30 meter <b>MCHF4 + \$35</b> High Flex 4 meter <b>MCHF8 + \$60</b> High Flex 8 meter <b>MCHF15 *</b> High Flex 15 meter <b>MCHF30 *</b> High Flex 30 meter
(*) Call for pricing					

Dimensions: W 3" L 3" H 1.125" Wgt .51 lbs



<b>MBL24</b> 2" X 4" Back Light LED - Package Includes Light, LDM 700, and 4 Meter Cable	<b>\$900</b>	<b>470 + \$0</b> Blue <b>530 + \$0</b> Green <b>630 + \$0</b> Red <b>850 + \$40</b> Infrared <b>WHI + \$0</b> White	<b>WD + \$0</b> White Diffuser <b>CC + \$0</b> Clear Cover <b>SD + \$0</b> Standard Diffuser <b>TFD + \$25</b> Thin Film Diffuser <b>P + \$25</b> Polarizer <b>DD + \$25</b> Distortion Diffuser <b>LCF *</b> Light Collimating Film	<b>LDM700 + \$0</b> 700mA Driver <b>A + \$85</b> ALDM Driver <b>V + \$85</b> VLDM Driver <b>RV + \$100</b> RVLDM Driver	<b>MC4 + \$0</b> 4 meter <b>MC8 + \$20</b> 8 meter <b>MC15 + \$60</b> 15 meter <b>MC30 *</b> 30 meter <b>MCHF4 + \$35</b> High Flex 4 meter <b>MCHF8 + \$60</b> High Flex 8 meter <b>MCHF15 *</b> High Flex 15 meter <b>MCHF30 *</b> High Flex 30 meter
(*) Call for pricing					

Dimensions: W 3" L 5" H 1" Wgt .5 lbs

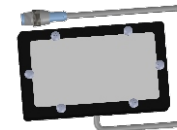



<b>MBL44</b> 4" X 4" Back Light LED - Package Includes Light, LDM 1400, and 4 Meter Cable	<b>\$1350</b>	<b>470 + \$0</b> Blue <b>530 + \$0</b> Green <b>630 + \$0</b> Red <b>850 + \$80</b> Infrared <b>WHI + \$0</b> White	<b>WD + \$0</b> White Diffuser <b>CC + \$0</b> Clear Cover <b>SD + \$0</b> Standard Diffuser <b>TFD + \$25</b> Thin Film Diffuser <b>P + \$25</b> Polarizer <b>DD + \$25</b> Distortion Diffuser <b>LCF *</b> Light Collimating Film	<b>LDM1400 + \$0</b> 1400mA Driver <b>A + \$85</b> ALDM Driver <b>V + \$85</b> VLDM Driver <b>RV + \$100</b> RVLDM Driver	<b>MC4 + \$0</b> 4 meter <b>MC8 + \$20</b> 8 meter <b>MC15 + \$60</b> 15 meter <b>MC30 *</b> 30 meter <b>MCHF4 + \$35</b> High Flex 4 meter <b>MCHF8 + \$60</b> High Flex 8 meter <b>MCHF15 *</b> High Flex 15 meter <b>MCHF30 *</b> High Flex 30 meter
(*) Call for pricing					

Dimensions: W 5" L 5" H 1" Wgt 1.25lbs



Monster-Series Back Lights

1	Base Part Number	List Price	2 LED	3 Diffuser	4 Driver	5 Cable
	<b>MBL46</b>	<b>\$1650</b>	<b>470 + \$0</b> Blue	<b>WD + \$0</b> White Diffuser	<b>LDM2100 + \$0</b> 2100mA Driver	<b>MC4 + \$0</b> 4 meter
	4" X 6" Back Light LED - Package Includes Light, LDM 2100, and 4 Meter Cable		<b>530 + \$0</b> Green	<b>CC + \$0</b> Clear Cover	<b>A + \$85</b> ALDM Driver	<b>MC8 + \$20</b> 8 meter
			<b>630 + \$0</b> Red	<b>SD + \$0</b> Standard Diffuser	<b>V + \$85</b> VLDM Driver	<b>MC15 + \$60</b> 15 meter
			<b>850 + \$120</b> Infrared	<b>TFD + \$25</b> Thin Film Diffuser	<b>RV + \$100</b> RVLDM Driver	<b>MC30 *</b> 30 meter
			<b>WHI + \$0</b> White	<b>P + \$35</b> Polarizer		<b>MCHF4 + \$35</b> High Flex 4 meter
			<b>DD + \$25</b> Distortion Diffuser		<b>MCHF8 + \$60</b> High Flex 8 meter	
			<b>LCF *</b> Light Collimating Film		<b>MCHF15 *</b> High Flex 15 meter	
						<b>MCHF30 *</b> High Flex 30 meter
<p>Dimensions: W 5" L 7" H 1" Wgt 1.95 lbs</p> <p style="text-align: right;">(*) Call for pricing</p>						

	<b>MBL48</b>	<b>\$2150</b>	<b>470 + \$0</b> Blue	<b>WD + \$0</b> White Diffuser	<b>LDM2800 + \$0</b> 2800mA Driver	<b>MC4 + \$0</b> 4 meter
	4" X 6" Back Light LED - Package Includes Light, LDM 2800, and 4 Meter Cable		<b>530 + \$0</b> Green	<b>CC + \$0</b> Clear Cover	<b>A + \$85</b> ALDM Driver	<b>MC8 + \$20</b> 8 meter
			<b>630 + \$0</b> Red	<b>SD + \$0</b> Standard Diffuser	<b>V + \$85</b> VLDM Driver	<b>MC15 + \$60</b> 15 meter
			<b>850 + \$160</b> Infrared	<b>TFD + \$25</b> Thin Film Diffuser	<b>RV + \$100</b> RVLDM Driver	<b>MC30 *</b> 30 meter
			<b>WHI + \$0</b> White	<b>P + \$40</b> Polarizer		<b>MCHF4 + \$35</b> High Flex 4 meter
			<b>DD + \$25</b> Distortion Diffuser		<b>MCHF8 + \$60</b> High Flex 8 meter	
			<b>LCF *</b> Light Collimating Film		<b>MCHF15 *</b> High Flex 15 meter	
						<b>MCHF30 *</b> High Flex 30 meter
<p>Dimensions: W 5" L 9" H 1" Wgt 1.95 lbs</p> <p style="text-align: right;">(*) Call for pricing</p>						

This page is intentionally blank

## Diffused Axial

Monster-Series Diffused Axial Lights - External Driver Included 19-20

## Monster-Series Diffused Axial Lights

### Features:

- External driver/controller included
- High speed strobe technology
- High power LED's (24 VDC)
- DIN rail mount driver/controller
- M12 connector for quick disconnect
- Available in 8 colors and Infrared
- Available in 2 sizes
- 10 Year Warranty\* - 100,000 hours

### Caution –

The supplied LDM adapter must be used for both continuous or strobe operations! Do not connect the fixture directly to 24VDC! Operating the fixture without the supplied LDM adapter will result in premature LED failure and will void the warranty.

### To Order, Specify;

1 Base Part Number	<b>MDA2</b>
Example:	<b>\$1200</b>
2 Specify LED Color	<b>470</b> <b>+ \$0</b>
3 Specify Driver Option	<b>A</b> <b>+ \$85</b>
4 Specify Cable Option	<b>MC4</b> <b>+ \$0</b>

1 Base Part Number	List Price	2 LED Color	3 Driver Option	4 Cable Type
<b>MDA2</b> 2" Diffused Axial Light W/ LED - Package Includes Light, LDM 350/2, and 4 Meter Cable	<b>\$1200</b>	<b>470 + \$0</b> Blue <b>530 + \$0</b> Green <b>630 + \$0</b> Red <b>850 + \$30</b> Infrared <b>WHI + \$0</b> White <b>NWH + \$0</b> Neutral White	<b>LDM350/2 + \$0</b> 350mA 2-4 LED Driver DIN Rail Mount <b>A + \$85</b> ALDM Driver <b>V + \$85</b> VLDM Driver <b>RV + \$100</b> RVLDM Driver	<b>MC4 + \$0</b> Monster Cable 4 meter <b>MC8 + \$20</b> Monster Cable 8 meter <b>MC15 + \$60</b> Monster Cable 15 meter <b>MC30 *</b> Monster Cable 30 meter <b>MCHF4 + \$35</b> Monster High Flex Cable 4 meter <b>MCHF8 + \$60</b> Monster High Flex Cable 8 meter <b>MCHF15 *</b> Monster High Flex Cable 15 meter <b>MCHF30 *</b> Monster High Flex Cable 30 meter
				
<b>Standard Dimensions</b>				
<b>W</b> 2.25"				
<b>L</b> 2.209"				
<b>H</b> 4.145"				
<b>Wgt</b> .7 lbs				<b>*Call for pricing</b>

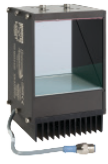
<b>MDA4</b> 4" Diffused Axial Light W/ LED - Package Includes Light, LDM 1400, and 4 Meter Cable	<b>\$3250</b>	<b>470 + \$0</b> Blue <b>530 + \$0</b> Green <b>630 + \$0</b> Red <b>850 + \$100</b> Infrared <b>WHI + \$0</b> White <b>NWH + \$200</b> Neutral White	<b>LDM1400 + \$0</b> 1400mA LED Driver DIN Rail Mount <b>A + \$85</b> ALDM Driver <b>V + \$85</b> VLDM Driver <b>RV + \$100</b> RVLDM Driver	<b>MC4 + \$0</b> Monster Cable 4 meter <b>MC8 + \$20</b> Monster Cable 8 meter <b>MC15 + \$60</b> Monster Cable 15 meter <b>MC30 *</b> Monster Cable 30 meter <b>MCHF4 + \$35</b> Monster High Flex Cable 4 meter <b>MCHF8 + \$60</b> Monster High Flex Cable 8 meter <b>MCHF15 *</b> Monster High Flex Cable 15 meter <b>MCHF30 *</b> Monster High Flex Cable 30 meter
				
<b>Standard Dimensions</b>				
<b>W</b> 4.38"				
<b>L</b> 4.25"				
<b>H</b> 6.82"				
<b>Wgt</b> 3 lbs				<b>*Call for pricing</b>

## MDA2 Diffused Axial Bracket

Features:

- Modular designed to fit DL180, DLD180 or MDL7.25 Dome Lights
- Available in 1 size
- 10 Year Warranty

MDA2-Bracket is used with Diffused Axial Light and Dome Lights to eliminate the appearance of camera viewing hole.

To Order, Specify;	
1 Base Part Number	MDA2-Bracket
Example:	\$225

1 Base Part Number	List Price
<b>MDA2-Bracket</b>	<b>\$225</b>

Mounts MDA2 Light to DL180, DLD180 or MDL7.25 Dome Lights

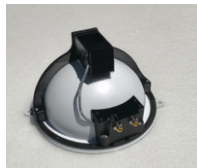

Standard Dimensions

W	14"
L	44"
H	7.50"
Wgt	1 lbs

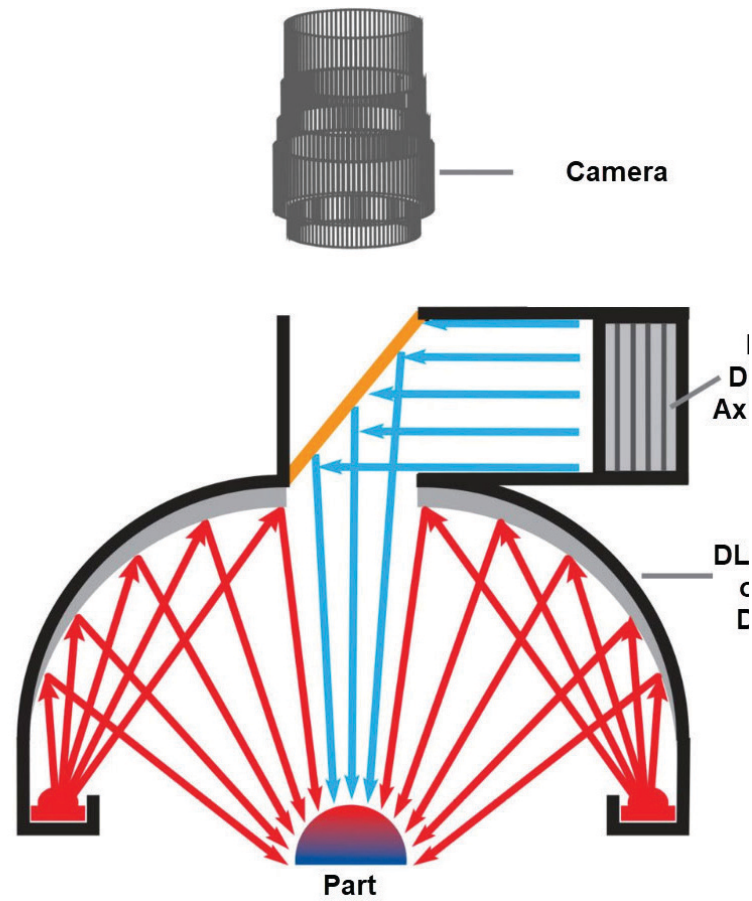

This page is intentionally blank

## Dome Lights

Monster-Series Multi-Channel Dome Lights - External Driver	23-25
Monster-Series Multi-Channel Dome Lights - Internal Driver	26-28
Monster-Series Dome Lights - External Driver	29-31

## Monster-Series Multi-Channel Dome Lights

### Features:

- External driver/controller included
- High speed strobe technology
- High power LED's (24 VDC)
- Support up to 4 pre loaded LED colors
- Custom Color LED's available
- M12 connector for quick disconnect
- Available in 6 colors, Ultra-Violet, Infrared
- Available in 1 size
- 10 Year Warranty\* - 100,000 hours

### Caution –

The supplied LDM adapter must be used for both continuous or strobe operations! Do not connect the fixture directly to 24VDC! Operating the fixture without the supplied LDM adapter will result in premature LED failure and will void the warranty.



### To Order, Specify;

1 Base Part Number	2 LED Color				3 Driver Option	4 Cable Option
	Channels					
	1	2	3	4		
<b>DL180-xx</b>	<b>W</b>	<b>B</b>	<b>X</b>	<b>X</b>	<b>A</b>	<b>SC4-8</b>
<b>\$750</b>	<b>\$0</b>	<b>\$0</b>	<b>-</b>	<b>-</b>	<b>\$85</b>	<b>\$0</b>

Dome lights also referred to as "cloudy-day illumination" provide uniform illumination with no reflections or shadows. They are ideal for highly reflective objects or if your application requires even lighting over the area of inspection.

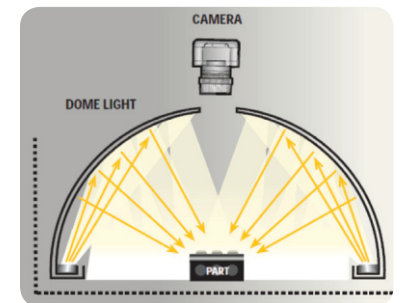

### Application Examples



**Object: Embossed Logo on Metallic Surface**  
Dome light removes the glare and provides a high contrast image.

### Monster-Series Multi-Channel Dome Lights

1	Base Part Number	List Price	1	2	2 LED	3	4	3 Driver	4 Cable
	<b>DL180-X</b>	<b>\$2000</b>	395 *					<b>V + \$0</b>	<b>SC4-8 + \$0</b>
	180mm Dome Light With 1 Channel/Color LED's - Package Includes Light, VLDM 700 and 4 Meter Cable		UV 395nm					VLDM Driver	4 meter 8 wire
			365 *					<b>A + \$0</b>	<b>SC8-8 + \$100</b>
			UV 365nm					ALDM Driver	8 meter 8 wire
			<b>B + \$0</b>					<b>RV + \$100</b>	
			Blue					RVLDM Driver	
			<b>G + \$0</b>						
			Green						
			<b>R + \$0</b>						
			Red						
			<b>850 + \$100</b>						
			Infrared						
			<b>940 *</b>						
			Infrared						
			<b>W + \$0</b>						
			White						
			<b>NW + \$0</b>						
			Neutral White						



1 LED Color picks allowed

Dimensions: D 14" CC 43.96" H 5.275" Wgt 2.85 lbs

(\* Call for pricing)

	<b>DL180-XX</b>	<b>\$2300</b>	395 *	395 *				<b>V + \$0</b>	<b>SC4-8 + \$0</b>
	180mm Dome Light With 2 Channel/Color LED's - Package Includes Light, 2 VLDM 700 and 4 Meter Cable		UV 395nm	UV 395nm				VLDM Driver	4 meter 8 wire
			365 *	365 *				<b>A + \$0</b>	<b>SC8-8 + \$100</b>
			UV 365nm	UV 365nm				ALDM Driver	8 meter 8 wire
			<b>B + \$0</b>	<b>B + \$0</b>				<b>RV + \$200</b>	
			Blue	Blue				RVLDM Driver	
			<b>G + \$0</b>	<b>G + \$0</b>					
			Green	Green					
			<b>R + \$0</b>	<b>R + \$0</b>					
			Red	Red					
			<b>850 + \$100</b>	<b>850 + \$100</b>					
			Infrared	Infrared					
			<b>940 *</b>	<b>940 *</b>					
			Infrared	Infrared					
			<b>W + \$0</b>	<b>W + \$0</b>					
			White	White					
			<b>NW + \$0</b>	<b>NW + \$0</b>					
			Neutral White	Neutral White					



2 LED Color picks allowed

Dimensions: D 14" CC 43.96" H 5.275" Wgt 2.85 lbs

(\* Call for pricing)

	<b>DL180-XXX</b>	<b>\$2600</b>	395 *	395 *	395 *			<b>V + \$0</b>	<b>SC4-8 + \$0</b>
	180mm Dome Light With 3 Channel/Color LED's - Package Includes Light, 3 VLDM 700 and 4 Meter Cable		UV 395nm	UV 395nm	UV 395nm			VLDM Driver	4 meter 8 wire
			365 *	365 *	365 *			<b>A + \$0</b>	<b>SC8-8 + \$100</b>
			UV 365nm	UV 365nm	UV 365nm			ALDM Driver	8 meter 8 wire
			<b>B + \$0</b>	<b>B + \$0</b>	<b>B + \$0</b>			<b>RV + \$300</b>	
			Blue	Blue	Blue			RVLDM Driver	
			<b>G + \$0</b>	<b>G + \$0</b>	<b>G + \$0</b>				
			Green	Green	Green				
			<b>R + \$0</b>	<b>R + \$0</b>	<b>R + \$0</b>				
			Red	Red	Red				
			<b>850 + \$100</b>	<b>850 + \$100</b>	<b>850 + \$100</b>				
			Infrared	Infrared	Infrared				
			<b>940 *</b>	<b>940 *</b>	<b>940 *</b>				
			Infrared	Infrared	Infrared				
			<b>W + \$0</b>	<b>W + \$0</b>	<b>W + \$0</b>				
			White	White	White				
			<b>NW + \$0</b>	<b>NW + \$0</b>	<b>NW + \$0</b>				
			Neutral White	Neutral White	Neutral White				



3 LED Color picks allowed

Dimensions: D 14" CC 43.96" H 5.275" Wgt 2.85 lbs

(\* Call for pricing)

### Monster-Series Multi-Channel Dome Lights

1	Base Part Number	List Price	1	2	2 LED	3	4	3 Driver	4 Cable
	<b>DL180-XXXX</b>	<b>\$2900</b>	395 *	395 *	395 *	395 *		<b>V + \$0</b>	<b>SC4-8 + \$0</b>
	180mm Dome Light With 4 Channel/Color LED's - Package Includes Light, 4 VLDM 700 and 4 Meter Cable		UV 395nm	UV 395nm	UV 395nm	UV 395nm		VLDM Driver	4 meter 8 wire
			365 *	365 *	365 *	365 *		<b>A + \$0</b>	<b>SC8-8 + \$100</b>
			UV 365nm	UV 365nm	UV 365nm	UV 365nm		ALDM Driver	8 meter 8 wire
			<b>B + \$0</b>	<b>B + \$0</b>	<b>B + \$0</b>	<b>B + \$0</b>		<b>RV + \$400</b>	
			Blue	Blue	Blue	Blue		RVLDM Driver	
			<b>G + \$0</b>	<b>G + \$0</b>	<b>G + \$0</b>	<b>G + \$0</b>			
			Green	Green	Green	Green			
			<b>R + \$0</b>	<b>R + \$0</b>	<b>R + \$0</b>	<b>R + \$0</b>			
			Red	Red	Red	Red			
			<b>850 + \$100</b>	<b>850 + \$100</b>	<b>850 + \$100</b>	<b>850 + \$100</b>			
			Infrared	Infrared	Infrared	Infrared			
			<b>940 *</b>	<b>940 *</b>	<b>940 *</b>	<b>940 *</b>			
			Infrared	Infrared	Infrared	Infrared			
			<b>W + \$0</b>	<b>W + \$0</b>	<b>W + \$0</b>	<b>W + \$0</b>			
			White	White	White	White			
			<b>NW + \$0</b>	<b>NW + \$0</b>	<b>NW + \$0</b>	<b>NW + \$0</b>			
			Neutral White	Neutral White	Neutral White	Neutral White			



4 LED Color picks allowed

Dimensions: D 14" CC 43.96" H 5.275" Wgt 2.85 lbs

(\* Call for pricing)

### Monster-Series Multi-Channel (Internal Driver) Dome Lights

Features:

- Internal Driver - Plug & Play
- Auto Burst Technology
- High power LED's (24 VDC)
- Supports up to 2 preloaded LED colors
- Custom Color LED's available
- M12 connector for quick disconnect
- Available in 6 colors and Infrared
- Available in 85mm and 180mm
- 0 - 10 VDC intensity Control
- Potentiometer Intensity Control
- 10 Year Warranty\* - 100,000 hours



To Order, Specify;

① Base Part Number	② LED Color Channels				③ Cable Option
	1	2	3	4	
<b>DLD85-x</b> \$1000	<b>W</b> \$0	<b>B</b> -	<b>X</b> -	<b>X</b> -	<b>Ec3</b> \$0

① Base Part Number	List Price	② LED				③ Cable
		1	2	3	4	

<b>DLD85-X</b> 85mm Dome Light With 1 Channel/Color LED's - Package Includes Light and one 3 Meter Cable	<b>\$1000</b>	<b>B + \$0</b> Blue	<b>G + \$0</b> Green	<b>R + \$0</b> Red	<b>850 *</b> Infrared	<b>940 *</b> Infrared	<b>W + \$0</b> White	<b>NW + \$0</b> Neutral White	<b>EC3 + \$0</b> 3M Cable	<b>EC5 + \$20</b> 5M Cable
---	---------------	------------------------	-------------------------	-----------------------	--------------------------	--------------------------	-------------------------	----------------------------------	------------------------------	-------------------------------



1 LED Color picks allowed

Dimensions: D 6.75" CC 21.2" H 3.257" Wgt .80 lbs

(\*) Call for pricing

### Monster-Series Multi-Channel (Internal Driver) Dome Lights

① Base Part Number	List Price	② LED				③ Cable
		1	2	3	4	

<b>DLD85-XX</b> 85mm Dome Light With 2 Channel/Color LED's - Package Includes Light and one 3 Meter Cable	<b>\$1250</b>	<b>B + \$0</b> Blue	<b>G + \$0</b> Green	<b>R + \$0</b> Red	<b>850 *</b> Infrared	<b>940 *</b> Infrared	<b>W + \$0</b> White	<b>NW + \$0</b> Neutral White	<b>B + \$0</b> Blue	<b>G + \$0</b> Green	<b>R + \$0</b> Red	<b>850 *</b> Infrared	<b>940 *</b> Infrared	<b>W + \$0</b> White	<b>NW + \$0</b> Neutral White	<b>EC3 + \$0</b> 3M Cable	<b>EC5 + \$20</b> 5M Cable
--	---------------	------------------------	-------------------------	-----------------------	--------------------------	--------------------------	-------------------------	----------------------------------	------------------------	-------------------------	-----------------------	--------------------------	--------------------------	-------------------------	----------------------------------	------------------------------	-------------------------------



2 LED Color picks allowed

Dimensions: D 6.75" CC 21.2" H 3.257" Wgt 1.0 lbs

(\*) Call for pricing

<b>DLD180-X</b> 180mm Dome Light With 1 Channel/Color LED's - Package Includes Light and three 3 Meter Cables	<b>\$2000</b>	<b>B + \$0</b> Blue	<b>G + \$0</b> Green	<b>R + \$0</b> Red	<b>850 *</b> Infrared	<b>940 *</b> Infrared	<b>W + \$0</b> White	<b>NW + \$0</b> Neutral White	<b>B + \$0</b> Blue	<b>G + \$0</b> Green	<b>R + \$0</b> Red	<b>850 *</b> Infrared	<b>940 *</b> Infrared	<b>W + \$0</b> White	<b>NW + \$0</b> Neutral White	<b>EC3 + \$0</b> 3M Cable	<b>EC5 + \$20</b> 5M Cable
--	---------------	------------------------	-------------------------	-----------------------	--------------------------	--------------------------	-------------------------	----------------------------------	------------------------	-------------------------	-----------------------	--------------------------	--------------------------	-------------------------	----------------------------------	------------------------------	-------------------------------



1 LED Color picks allowed

Dimensions: D 14" CC 43.96" H 5.275" Wgt 2.5 lbs

(\*) Call for pricing

<b>DLD180-XX</b> 180mm Dome Light With 2 Channel/Color LED's - Package Includes Light and three 3 Meter Cables	<b>\$2300</b>	<b>B + \$0</b> Blue	<b>G + \$0</b> Green	<b>R + \$0</b> Red	<b>850 *</b> Infrared	<b>940 *</b> Infrared	<b>W + \$0</b> White	<b>NW + \$0</b> Neutral White	<b>B + \$0</b> Blue	<b>G + \$0</b> Green	<b>R + \$0</b> Red	<b>850 *</b> Infrared	<b>940 *</b> Infrared	<b>W + \$0</b> White	<b>NW + \$0</b> Neutral White	<b>EC3 + \$0</b> 3M Cable	<b>EC5 + \$20</b> 5M Cable
---	---------------	------------------------	-------------------------	-----------------------	--------------------------	--------------------------	-------------------------	----------------------------------	------------------------	-------------------------	-----------------------	--------------------------	--------------------------	-------------------------	----------------------------------	------------------------------	-------------------------------



2 LED Color picks allowed

Dimensions: D14" CC 43.96" H 5.275" Wgt 2.5 lbs

(\*) Call for pricing

### Monster-Series Multi-Channel (Internal Driver) Dome Lights

1 Base Part Number	List Price	2 LED				3 Cable
		1	2	3	4	
<b>DLD180-XXX</b> 180mm Dome Light With 3 Channel/Color LED's - Package Includes Light and three 3 Meter Cables	<b>\$2600</b>	<b>B + \$0</b> Blue	<b>B + \$0</b> Blue	<b>B + \$0</b> Blue	<b>B + \$0</b> Blue	<b>EC3 + \$0</b> 3M Cable
		<b>G + \$0</b> Green	<b>G + \$0</b> Green	<b>G + \$0</b> Green	<b>G + \$0</b> Green	<b>EC5 + \$20</b> 5M Cable
		<b>R + \$0</b> Red	<b>R + \$0</b> Red	<b>R + \$0</b> Red	<b>R + \$0</b> Red	
		<b>850 *</b> Infrared	<b>850 *</b> Infrared	<b>850 *</b> Infrared	<b>850 *</b> Infrared	
		<b>940 *</b> Infrared	<b>940 *</b> Infrared	<b>940 *</b> Infrared	<b>940 *</b> Infrared	
		<b>W + \$0</b> White	<b>W + \$0</b> White	<b>W + \$0</b> White	<b>W + \$0</b> White	
		<b>NW + \$0</b> Neutral White	<b>NW + \$0</b> Neutral White	<b>NW + \$0</b> Neutral White	<b>NW + \$0</b> Neutral White	

1 LED Color picks allowed

Dimensions: D 14" CC 43.96" H 5.275" Wgt 2.5 lbs

(\* Call for pricing)

<b>DLD180-XXXX</b> 180mm Dome Light With 4 Channel/Color LED's - Package Includes Light and three 3 Meter Cables	<b>\$2900</b>	<b>B + \$0</b> Blue	<b>B + \$0</b> Blue	<b>B + \$0</b> Blue	<b>B + \$0</b> Blue	<b>EC3 + \$0</b> 3M Cable
		<b>G + \$0</b> Green	<b>G + \$0</b> Green	<b>G + \$0</b> Green	<b>G + \$0</b> Green	<b>EC5 + \$20</b> 5M Cable
		<b>R + \$0</b> Red	<b>R + \$0</b> Red	<b>R + \$0</b> Red	<b>R + \$0</b> Red	
		<b>850 *</b> Infrared	<b>850 *</b> Infrared	<b>850 *</b> Infrared	<b>850 *</b> Infrared	
		<b>940 *</b> Infrared	<b>940 *</b> Infrared	<b>940 *</b> Infrared	<b>940 *</b> Infrared	
		<b>W + \$0</b> White	<b>W + \$0</b> White	<b>W + \$0</b> White	<b>W + \$0</b> White	
		<b>NW + \$0</b> Neutral White	<b>NW + \$0</b> Neutral White	<b>NW + \$0</b> Neutral White	<b>NW + \$0</b> Neutral White	

1 LED Color picks allowed

Dimensions: D 14" CC 43.96" H 5.275" Wgt 2.5 lbs

(\* Call for pricing)

### Monster-Series Dome Lights

- Features:
- External driver/controller included
  - High speed strobe technology
  - High power LED's (24 VDC)
  - Custom Color LED's available
  - Multi-channel option (DL-180) available
  - M12 connector for quick disconnect
  - Available in 6 colors, Ultra-Violet, Infrared
  - Available in 4 sizes
  - 10 Year Warranty\* - 100,000 hours

**Caution –**

The supplied LDM adapter must be used for both continuous or strobe operations! Do not connect the fixture directly to 24VDC! Operating the fixture without the supplied LDM adapter will result in premature LED failure and will void the warranty.

To Order, Specify;	
1 Base Part Number	<b>MDL7.25</b>
Example:	<b>\$2100</b>
2 Specify LED Color	<b>365</b>
	<b>+ \$75</b>
3 Specify Driver Option	<b>A</b>
	<b>+ \$85</b>
	<b>MC4</b>
4 Specify Cable Option	<b>+ \$0</b>

1 Base Part Number	List Price	2 LED Color		3 Driver Option	4 Cable Type
<b>MDL7.25</b> 7.25" Dome Light LED's - Package Includes Light, LDM 700, and 4 Meter Cable	<b>\$2100</b>	<b>365 + \$75</b> Ultraviolet 365nm	<b>LDM700 + \$0</b> 700mA Driver Rail Mount	<b>MC4 + \$0</b> 4 meter	
		<b>395 + \$0</b> Ultraviolet 395nm	<b>A + \$85</b> ALDM Driver	<b>MC8 + \$20</b> 8 meter	
		<b>470 + \$0</b> Blue	<b>V + \$85</b> VLDM Driver	<b>MC15 + \$60</b> 15 meter	
		<b>530 + \$0</b> Green	<b>RV + \$100</b> RVLDM Driver	<b>MC30 *</b> 30 meter	
		<b>630 + \$0</b> Red		<b>MCHF4 + \$35</b> High Flex 4 meter	
		<b>850 + \$75</b> Infrared		<b>MCHF8 + \$60</b> High Flex 8 meter	
		<b>940 *</b> Infrared		<b>MCHF15 *</b> High Flex 15 meter	
		<b>WHI + \$0</b> White		<b>MCHF30 *</b> High Flex 30 meter	
		<b>NWH + \$0</b> Neutral White			

Dimensions: D 15" CC 47.1" H 6.225" Wgt 6.1 lbs

(\* Call for pricing)

<b>MDL12.25</b> 12.25" Dome Light LED's - Package Includes Light, LDM 1400, and 4 Meter Cable	<b>\$2500</b>	<b>365 + \$150</b> Ultraviolet 365nm	<b>LDM1400 + \$0</b> 1400mA Driver Rail Mount	<b>MC4 + \$0</b> 4 meter
		<b>395 + \$0</b> Ultraviolet 395nm	<b>A + \$85</b> ALDM Driver	<b>MC8 + \$20</b> 8 meter
		<b>470 + \$0</b> Blue	<b>V + \$85</b> VLDM Driver	<b>MC15 + \$60</b> 15 meter
		<b>530 + \$0</b> Green	<b>RV + \$100</b> RVLDM Driver	<b>MC30 *</b> 30 meter
		<b>630 + \$0</b> Red		<b>MCHF4 + \$35</b> High Flex 4 meter
		<b>850 + \$150</b> Infrared		<b>MCHF8 + \$60</b> High Flex 8 meter
		<b>940 *</b> Infrared		<b>MCHF15 *</b> High Flex 15 meter
		<b>WHI + \$0</b> White		<b>MCHF30 *</b> High Flex 30 meter
		<b>NWH + \$0</b> Neutral White		

Dimensions: D 20" CC 62.8" H 8.725" Wgt 9 lbs

(\* Call for pricing)

Monster-Series Dome Lights

1 Base Part Number	List Price	2 LED Color	3 Driver Option	4 Cable Type
<b>MDL18.25</b> 18.25" Dome Light LED's - Package Includes Light, LDM 2100, and 4 Meter Cable 	<b>\$3650</b>	<b>365 + \$200</b> Ultraviolet 365nm	<b>LDM2100 + \$0</b> 2100mA Driver Rail Mount	<b>MC4 + \$0</b> 4 meter
		<b>395 + \$0</b> Ultraviolet 395nm	<b>A + \$85</b> ALDM Driver	<b>MC8 + \$20</b> 8 meter
		<b>470 + \$0</b> Blue	<b>V + \$85</b> VLDM Driver	<b>MC15 + \$60</b> 15 meter
		<b>530 + \$0</b> Green	<b>RV + \$100</b> RVLDM Driver	<b>MC30 *</b> 30 meter
		<b>630 + \$0</b> Red		<b>MCHF4 + \$35</b> High Flex 4 meter
		<b>850 + \$200</b> Infrared		<b>MCHF8 + \$60</b> High Flex 8 meter
		<b>940 *</b> Infrared		<b>MCHF15 *</b> High Flex 15 meter
		<b>WHI + \$0</b> White		<b>MCHF30 *</b> High Flex 30 meter
		<b>NWH + \$0</b> Neutral White		

Dimensions: D 23.125" CC 72.612" H 11.225" Wgt 14 lbs

(\* Call for pricing)

<b>MDL29.25</b> 29.25" Dome Light LED's - Package Includes Light, LDM 2800, and 4 Meter Cable 	<b>\$4500</b>	<b>365 + \$350</b> Ultraviolet 365nm	<b>LDM2800 + \$0</b> 2800mA Driver Rail Mount	<b>MC4 + \$0</b> 4 meter
		<b>395 + \$0</b> Ultraviolet 395nm	<b>A + \$85</b> ALDM Driver	<b>MC8 + \$20</b> 8 meter
		<b>470 + \$0</b> Blue	<b>V + \$85</b> VLDM Driver	<b>MC15 + \$60</b> 15 meter
		<b>530 + \$0</b> Green	<b>RV + \$100</b> RVLDM Driver	<b>MC30 *</b> 30 meter
		<b>630 + \$0</b> Red		<b>MCHF4 + \$35</b> High Flex 4 meter
		<b>850 + \$350</b> Infrared		<b>MCHF8 + \$60</b> High Flex 8 meter
		<b>940 *</b> Infrared		<b>MCHF15 *</b> High Flex 15 meter
		<b>WHI + \$0</b> White		<b>MCHF30 *</b> High Flex 30 meter
		<b>NWH + \$0</b> Neutral White		

Dimensions: D 34" CC 106.76" H 17.125" Wgt lbs

(\* Call for pricing)

This page is intentionally blank

## Linear Lights

Standard-Series Linear "Bright Field" Lights - No Driver Required	33-35
E-Series Linear Lights - Internal Driver	36-37
Monster-Series Linear "Bright Field" Lights - External Driver	38-45
Monster-Series Linear "Bright Field" Lights - Internal Driver	46-78
Monster-Series Xtreme Linear Lights - Internal Driver	49

## Standard-Series Linear Lights

### Features:

- No driver/controller required
- High speed built-in strobe
- 24VDC
- M12 connector for quick disconnect
- Available in Red and Infrared
- Available in 6 sizes
- 10 Year Warranty\* - 100,000 hours

### To Order, Specify;

1 Base Part Number	LA14
Example:	\$550
2 Specify LED Color	630 + \$0
3 Specify Diffuser Type	SD + \$0
4 Specify Cable Option	SC4 + \$0

1 Base Part Number	List Price	2 LED Color	3 Diffuser Type	4 Cable Option
<b>LA14</b> 1" X 4" Linear Light LED - Package Includes Light, and 4 Meter Cable	<b>\$550</b>	<b>630 + \$0</b> Red <b>880 + \$0</b> Infrared	<b>SD + \$0</b> Standard Diffuser <b>TFD + \$25</b> Thin Film Diffuser <b>WD + \$0</b> White Diffuser <b>P + \$25</b> Polarizer	<b>SC4 + \$0</b> 4 meter <b>SC8 + \$50</b> 8 meter <b>SC15 + \$85</b> 15 meter <b>SC30 *</b> 30 meter <b>SCHF4 + \$35</b> High Flex 4 meter <b>SCHF8 + \$60</b> High Flex 8 meter <b>SCHF15 + \$160</b> High Flex 15 meter
				
<b>Dimensions: W 2" L 5" H 1.125" Wgt .55 lbs</b> <span style="float: right;">(*) Call for pricing</span>				

<b>LA18</b> 1"X 8"Linear Light LED - Package Includes Light, and 4 Meter Cable	<b>\$700</b>	<b>630 + \$0</b> Red <b>880 + \$0</b> Infrared	<b>SD + \$0</b> Standard Diffuser <b>TFD + \$25</b> Thin Film Diffuser <b>WD + \$0</b> White Diffuser <b>P + \$25</b> Polarizer	<b>SC4 + \$0</b> 4 meter <b>SC8 + \$50</b> 8 meter <b>SC15 + \$85</b> 15 meter <b>SC30 *</b> 30 meter <b>SCHF4 + \$35</b> High Flex 4 meter <b>SCHF8 + \$60</b> High Flex 8 meter <b>SCHF15 + \$160</b> High Flex 15 meter
				
<b>Dimensions: W 2" L 9" H 1.125" Wgt .95 lbs</b> <span style="float: right;">(*) Call for pricing</span>				

Standard-Series Linear Lights

1 Base Part Number	List Price	2 LED Color	3 Diffuser Type	4 Cable Option
<b>LA112</b> 1" X 12" Linear Light LED - Package Includes Light, and 4 Meter Cable 	<b>\$1100</b>	<b>630 + \$0</b> Red	<b>SD + \$0</b> Standard Diffuser	<b>SC4 + \$0</b> 4 meter
		<b>880 + \$0</b> Infrared	<b>TFD + \$25</b> Thin Film Diffuser	<b>SC8 + \$50</b> 8 meter
			<b>WD + \$0</b> White Diffuser	<b>SC15 + \$85</b> 15 meter
			<b>P + \$25</b> Polarizer	<b>SC30 *</b> 30 meter
				<b>SCHF4 + \$35</b> High Flex 4 meter
			<b>SCHF8 + \$60</b> High Flex 8 meter	
			<b>SCHF15 + \$160</b> High Flex 15 meter	

Dimensions: W 2" L 13" H 1.25" Wgt lbs

(\* Call for pricing)

<b>LA116</b> 1" X 16" Linear Light LED - Package Includes Light, and 4 Meter Cable 	<b>\$1400</b>	<b>630 + \$0</b> Red	<b>SD + \$0</b> Standard Diffuser	<b>SC4 + \$0</b> 4 meter
		<b>880 + \$0</b> Infrared	<b>TFD + \$25</b> Thin Film Diffuser	<b>SC8 + \$50</b> 8 meter
			<b>WD + \$0</b> White Diffuser	<b>SC15 + \$85</b> 15 meter
			<b>P + \$25</b> Polarizer	<b>SC30 *</b> 30 meter
				<b>SCHF4 + \$35</b> High Flex 4 meter
			<b>SCHF8 + \$60</b> High Flex 8 meter	
			<b>SCHF15 + \$160</b> High Flex 15 meter	

Dimensions: W 2" L 17" H 1.125" Wgt 2.02 lbs

(\* Call for pricing)

<b>LA124</b> 1" X 24" Linear Light LED - Package Includes Light, and 4 Meter Cable 	<b>\$1800</b>	<b>630 + \$0</b> Red	<b>SD + \$0</b> Standard Diffuser	<b>SC4 + \$0</b> 4 meter
		<b>880 + \$0</b> Infrared	<b>TFD + \$25</b> Thin Film Diffuser	<b>SC8 + \$50</b> 8 meter
			<b>WD + \$0</b> White Diffuser	<b>SC15 + \$85</b> 15 meter
			<b>P + \$25</b> Polarizer	<b>SC30 *</b> 30 meter
				<b>SCHF4 + \$35</b> High Flex 4 meter
			<b>SCHF8 + \$60</b> High Flex 8 meter	
			<b>SCHF15 + \$160</b> High Flex 15 meter	

Dimensions: W 2" L 25" H 1.125" Wgt 2.9 lbs

(\* Call for pricing)

Standard-Series Linear Lights

1 Base Part Number	List Price	2 LED Color	3 Diffuser Type	4 Cable Option
<b>LA24</b> 2"X 4" Linear Light LED - Package Includes Light, and 4 Meter Cable 	<b>\$700</b>	<b>630 + \$0</b> Red	<b>SD + \$0</b> Standard Diffuser	<b>SC4 + \$0</b> 4 meter
		<b>880 + \$0</b> Infrared	<b>TFD + \$25</b> Thin Film Diffuser	<b>SC8 + \$50</b> 8 meter
			<b>WD + \$0</b> White Diffuser	<b>SC15 + \$85</b> 15 meter
			<b>P + \$25</b> Polarizer	<b>SC30 *</b> 30 meter
				<b>SCHF4 + \$35</b> High Flex 4 meter
			<b>SCHF8 + \$60</b> High Flex 8 meter	
			<b>SCHF15 + \$160</b> High Flex 15 meter	

Dimensions: W 3" L 5" H 17.125" Wgt .7 lbs

(\* Call for pricing)

## E-Series Linear Lights

Features:

- Internal driver/controller included
- Auto Burst 3.5x Technology
- Thermal Protection to reduce downtime
- High Power LED's (24 VDC)
- M12 connector for quick disconnect
- Available in 4 colors, Ultra-Violet, Infrared
- Available in 3 sizes and 40mm Spot Light
- 10 Year Warranty\* - 50,000 hours



To Order, Specify;

1 Base Part Number	2 LED Color	3 Lens Type	4 Diffuser	5 Cable Option
<b>EL300</b> \$750	<b>470</b> \$0	<b>16</b> \$0	<b>CC</b> \$0	<b>EC5</b> \$20

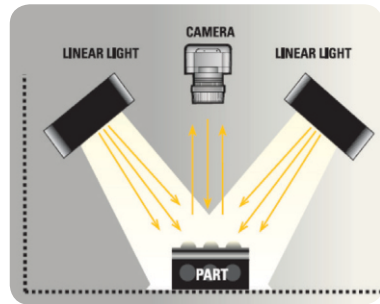

## E-Series Linear Lights

1 Base Part Number	List Price	2 LED	3 LensType	4 Diffuser	5 Cable
<b>EL150</b> E-Series 150mm Bar Light With LED's and 3 Meter Cable	<b>\$575</b>	<b>365 \$75</b> UV 365nm <b>395 + \$75</b> UV 395nm <b>470 + \$0</b> Blue <b>530 + \$0</b> Green <b>630 + \$0</b> Red <b>850 + \$75</b> Infrared <b>940 + \$75</b> Infrared <b>WHI + \$0</b> White	<b>16 + \$0</b> Optics 16 Frosted <b>23 + \$0</b> Optics 23 Frosted <b>39 + \$0</b> Optics 39 Frosted <b>R + \$0</b> Reflector 90 <b>L + \$0</b> Optics Line	<b>CC + \$0</b> Clear Cover <b>SD + \$0</b> Standard Diffuser <b>TFD + \$15</b> Thin Film Diffuser <b>WD + \$0</b> White Diffuser <b>P + \$25</b> Polarizer <b>UVCC + \$0</b> UV ClearCover	<b>EC3 + \$0</b> 3 Meter <b>EC5 + \$20</b> 5 Meter
Dimensions: W 1.506" L 8.799" H 1.181" Wgt .5 lbs					
(*) Call for pricing					

<b>EL300</b> E-Series 300mm Bar Light With LED's and 3 Meter Cable	<b>\$775</b>	<b>365 \$150</b> UV 365nm <b>395 + \$150</b> UV 395nm <b>470 + \$0</b> Blue <b>530 + \$0</b> Green <b>630 + \$0</b> Red <b>850 + \$150</b> Infrared <b>940 + \$150</b> Infrared <b>WHI + \$0</b> White	<b>16 + \$0</b> Optics 16 Frosted <b>23 + \$0</b> Optics 23 Frosted <b>39 + \$0</b> Optics 39 Frosted <b>R + \$0</b> Reflector 90 <b>L + \$0</b> Optics Line	<b>CC + \$0</b> Clear Cover <b>SD + \$0</b> Standard Diffuser <b>TFD + \$15</b> Thin Film Diffuser <b>WD + \$0</b> White Diffuser <b>P + \$50</b> Polarizer <b>UVCC + \$0</b> UV ClearCover	<b>EC3 + \$0</b> 3 Meter <b>EC5 + \$20</b> 5 Meter
Dimensions: W 1.506" L 14.705" H 1.181" Wgt .75 lbs					
(*) Call for pricing					

<b>EL2150</b> E-Series Double Row 150mm Bar Light LED's and 3 Meter Cable	<b>\$775</b>	<b>365 \$150</b> UV 365nm <b>395 + \$150</b> UV 395nm <b>470 + \$0</b> Blue <b>530 + \$0</b> Green <b>630 + \$0</b> Red <b>850 + \$150</b> Infrared <b>940 + \$150</b> Infrared <b>WHI + \$0</b> White	<b>16 + \$0</b> Optics 16 Frosted <b>23 + \$0</b> Optics 23 Frosted <b>39 + \$0</b> Optics 39 Frosted <b>R + \$0</b> Reflector 90 <b>L + \$0</b> Optics Line	<b>CC + \$0</b> Clear Cover <b>SD + \$0</b> Standard Diffuser <b>TFD + \$25</b> Thin Film Diffuser <b>WD + \$0</b> White Diffuser <b>P + \$50</b> Polarizer <b>UVCC + \$0</b> UV ClearCover	<b>EC3 + \$0</b> 3 Meter <b>EC5 + \$20</b> 5 Meter
Dimensions: W 2.362" L 14.705" H 8.799" Wgt .75 lbs					
(*) Call for pricing					

## Monster-Series Linear Lights

### Features:

- External driver/controller included
- High speed Strobe Technology
- High Power LED's (24 VDC)
- DIN rail mount driver/controller
- M12 connector for quick disconnect
- Available in 8 colors, Ultra-Violet, Infrared
- Available in 14 sizes
- 10 Year Warranty\* - 100,000 hours

### Caution –

The supplied LDM adapter must be used for both continuous or strobe operations! Do not connect the fixture directly to 24VDC! Operating the fixture without the supplied LDM adapter will result in premature LED failure and will void the warranty.

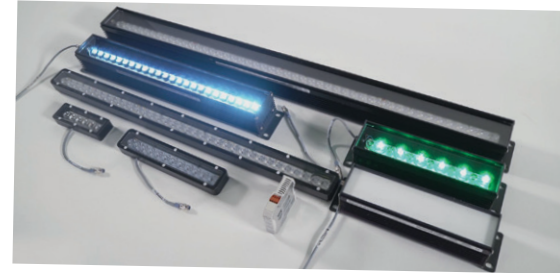

### To Order, Specify;

1 Base Part Number	2 LED Color	3 Lens	4 Diffusser	5 Driver Option	6 Cable Option
<b>MLL12</b>	<b>470</b>	<b>12</b>	<b>SD</b>	<b>A</b>	<b>MC4</b>
<b>\$500</b>	<b>\$0</b>	<b>\$0</b>	<b>\$0</b>	<b>\$85</b>	<b>\$0</b>

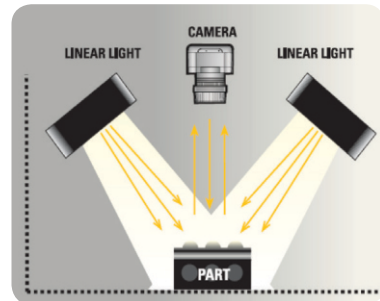

Bar lights use LED arrays in compact, linear units to provide economical illumination for a variety of tasks. Available in a variety of lengths, bar lights are useful for large area illumination when used in opposing pairs or in a picture frame mounting orientation. Bar Lights can also be used in place of Spot or Ring Lights when greater intensity is required.

### Application Examples



**Object: Dental Implant Inspection.** Inspects for defects in implants. UV light illuminates implant defects.

## Monster-Series Linear Lights

1 Base Part Number	List Price	2 LED	3 Lens	4 Diffuser	5 Driver	6 Cable
<b>MLL12</b>	<b>\$500</b>	<b>365 + \$25</b> UV 365nm	<b>12 + \$0</b> 12 Degree	<b>SD + \$0</b> Standard	<b>LDM350/2 + \$0</b> 350mA Driver	<b>MC4 + \$0</b> 4 meter
2" Linear Light LED's - Package Includes Light, LDM 350/2, and 4 Meter Cable		<b>395 + \$25</b> UV 395nm	<b>16 + \$0</b> 16 Frosted	<b>CC + \$0</b> Clear Cover	<b>A + \$85</b> ALDM Driver	<b>MC8 + \$20</b> 8 meter
		<b>470 + \$0</b> Blue	<b>23 + \$0</b> 23 Frosted	<b>TFD + \$25</b> Thin Film	<b>V + \$85</b> VLDM Driver	<b>MC15 + \$60</b> 15 meter
		<b>530 + \$0</b> Green	<b>30 + \$0</b> 30 Frosted	<b>WD + \$0</b> White	<b>RV + \$100</b> RVLDM Driver	<b>MC30 *</b> 30 meter
		<b>630 + \$0</b> Red	<b>39 + \$0</b> 39 Frosted	<b>P + \$25</b> Polarizer		<b>MCHF4 + \$35</b> High Flex 4 meter
		<b>850 + \$25</b> Infrared	<b>50 + \$0</b> 50 Degree	<b>UVCC + \$0</b> UV Clear Cover		<b>MCHF8 + \$60</b> High Flex 8 meter
		<b>940 + \$25</b> Infrared	<b>F + \$0</b> Wide Angle			<b>MCHF15 *</b> High Flex 15 meter
		<b>WHI + \$0</b> White	<b>R + \$0</b> Reflector 90			<b>MCHF30 *</b> High Flex 30 meter
		<b>NWH + \$0</b> Neutral White	<b>L + \$0</b> Line			

Dimensions: W 2" L 3" H 1.125" Wgt .4 lbs

(\* Call for pricing)

<b>MLL14</b>	<b>\$550</b>	<b>365 + \$50</b> UV 365nm	<b>12 + \$0</b> 12 Degree	<b>SD + \$0</b> Standard	<b>LDM350/2 + \$0</b> 350mA Driver	<b>MC4 + \$0</b> 4 meter
4" Linear Light LED's - Package Includes Light, LDM 350/2, and 4 Meter Cable		<b>395 + \$50</b> UV 395nm	<b>16 + \$0</b> 16 Frosted	<b>CC + \$0</b> Clear Cover	<b>A + \$85</b> ALDM Driver	<b>MC8 + \$20</b> 8 meter
		<b>470 + \$0</b> Blue	<b>23 + \$0</b> 23 Frosted	<b>TFD + \$25</b> Thin Film	<b>V + \$85</b> VLDM Driver	<b>MC15 + \$60</b> 15 meter
		<b>530 + \$0</b> Green	<b>30 + \$0</b> 30 Frosted	<b>WD + \$0</b> White	<b>RV + \$100</b> RVLDM Driver	<b>MC30 *</b> 30 meter
		<b>630 + \$0</b> Red	<b>39 + \$0</b> 39 Frosted	<b>P + \$25</b> Polarizer		<b>MCHF4 + \$35</b> High Flex 4 meter
		<b>850 + \$50</b> Infrared	<b>50 + \$0</b> 50 Degree	<b>UVCC + \$0</b> UV Clear Cover		<b>MCHF8 + \$60</b> High Flex 8 meter
		<b>940 + \$50</b> Infrared	<b>F + \$0</b> Wide Angle			<b>MCHF15 *</b> High Flex 15 meter
		<b>WHI + \$0</b> White	<b>R + \$0</b> Reflector 90			<b>MCHF30 *</b> High Flex 30 meter
		<b>NWH + \$0</b> Neutral White	<b>L + \$0</b> Line			

Dimensions: W 2" L 5" H 1.125" Wgt .6 lbs

(\* Call for pricing)

<b>MLL16</b>	<b>\$650</b>	<b>365 + \$50</b> UV 365nm	<b>12 + \$0</b> 12 Degree	<b>SD + \$0</b> Standard	<b>LDM350/3 + \$0</b> 350mA Driver	<b>MC4 + \$0</b> 4 meter
6" Linear Light LED's - Package Includes Light, LDM 350/3 (LDM 350/2 For Ir), and 4 Meter Cable		<b>395 + \$50</b> UV 395nm	<b>16 + \$0</b> 16 Frosted	<b>CC + \$0</b> Clear Cover	<b>A + \$85</b> ALDM Driver	<b>MC8 + \$20</b> 8 meter
		<b>470 + \$0</b> Blue	<b>23 + \$0</b> 23 Frosted	<b>TFD + \$25</b> Thin Film	<b>V + \$85</b> VLDM Driver	<b>MC15 + \$60</b> 15 meter
		<b>530 + \$0</b> Green	<b>30 + \$0</b> 30 Frosted	<b>WD + \$0</b> White	<b>RV + \$100</b> RVLDM Driver	<b>MC30 *</b> 30 meter
		<b>630 + \$0</b> Red	<b>39 + \$0</b> 39 Frosted	<b>P + \$25</b> Polarizer		<b>MCHF4 + \$35</b> High Flex 4 meter
		<b>850 + \$50</b> Infrared	<b>50 + \$0</b> 50 Degree	<b>UVCC + \$0</b> UV Clear Cover		<b>MCHF8 + \$60</b> High Flex 8 meter
		<b>940 + \$75</b> Infrared	<b>F + \$0</b> Wide Angle			<b>MCHF15 *</b> High Flex 15 meter
		<b>WHI + \$0</b> White	<b>R + \$0</b> Reflector 90			<b>MCHF30 *</b> High Flex 30 meter
		<b>NWH + \$0</b> Neutral White	<b>L + \$0</b> Line			

Dimensions: W 2.25" L 6.25" H 1.125" Wgt .8 lbs

(\* Call for pricing)

Monster-Series Linear Lights

1 Base Part Number	List Price	2 LED	3 Lens	4 Diffuser	5 Driver	6 Cable
<b>MLL111.5</b> 11.5" Linear Light LED's - Package Includes Light, LDM 700, and 4 Meter Cable	<b>\$775</b>	<b>365 + \$100</b> UV 365nm <b>395 + \$100</b> UV 395nm <b>470 + \$0</b> Blue <b>530 + \$0</b> Green <b>630 + \$0</b> Red <b>850 + \$100</b> Infrared <b>940 + \$150</b> Infrared <b>WHI + \$0</b> White <b>NWH + \$0</b> Neutral White	<b>12 + \$0</b> 12 Degree <b>16 + \$0</b> 16 Frosted <b>23 + \$0</b> 23 Frosted <b>30 + \$0</b> 30 Frosted <b>39 + \$0</b> 39 Frosted <b>50 + \$0</b> 50 Degree <b>F + \$0</b> Wide Angle <b>R + \$0</b> Reflector 90 <b>L + \$0</b> Line	<b>SD + \$0</b> Standard <b>CC + \$0</b> Clear Cover <b>TFD + \$25</b> Thin Film <b>WD + \$0</b> White <b>P + \$50</b> Polarizer <b>UVCC + \$0</b> UV Clear Cover	<b>LDM700 + \$0</b> 700mA Driver <b>A + \$85</b> ALDM Driver <b>V + \$85</b> VLDM Driver <b>RV + \$100</b> RVLDM Driver	<b>MC4 + \$0</b> 4 meter <b>MC8 + \$20</b> 8 meter <b>MC15 + \$60</b> 15 meter <b>MC30 *</b> 30 meter <b>MCHF4 + \$35</b> High Flex 4 meter <b>MCHF8 + \$60</b> High Flex 8 meter <b>MCHF15 *</b> High Flex 15 meter <b>MCHF30 *</b> High Flex 30 meter

Dimensions: W 2.5" L 12.5" H 1.125" Wgt 1.45 lbs

(\*) Call for pricing

<b>MLL111.5-xxx-yyy</b> 11.5" Linear Light LED's - Package Includes Light, LDM 700, and 4 Meter Cable	<i>call for pricing</i>	<b>365 + \$50</b> UV 365nm <b>395 + \$50</b> UV 395nm <b>470 + \$0</b> Blue <b>530 + \$0</b> Green <b>630 + \$0</b> Red <b>850 + \$50</b> Infrared <b>940 + \$75</b> Infrared <b>WHI + \$0</b> White <b>NWH + \$0</b> Neutral White	<b>12 + \$0</b> 12 Degree <b>16 + \$0</b> 16 Frosted <b>23 + \$0</b> 23 Frosted <b>30 + \$0</b> 30 Frosted <b>39 + \$0</b> 39 Frosted <b>50 + \$0</b> 50 Degree <b>F + \$0</b> Wide Angle <b>R + \$0</b> Reflector 90 <b>L + \$0</b> Line	<b>SD + \$0</b> Standard <b>CC + \$0</b> Clear Cover <b>TFD + \$25</b> Thin Film <b>WD + \$0</b> White <b>P + \$50</b> Polarizer <b>UVCC + \$0</b> UV Clear Cover	<b>LDM1050 + \$0</b> 1050mA Driver <b>A + \$85</b> ALDM Driver <b>V + \$85</b> VLDM Driver <b>RV + \$100</b> RVLDM Driver	<b>MC4 + \$0</b> 4 meter <b>MC8 + \$20</b> 8 meter <b>MC15 + \$60</b> 15 meter <b>MC30 *</b> 30 meter <b>MCHF4 + \$35</b> High Flex 4 meter <b>MCHF8 + \$60</b> High Flex 8 meter <b>MCHF15 *</b> High Flex 15 meter <b>MCHF30 *</b> High Flex 30 meter
--	-------------------------	--	--	--	--	--

Dimensions: W 2.5" L 12.5" H 1.125" Wgt 1.45 lbs

(\*) Call for pricing

<b>MLL117.25</b> 17.5" Linear Light LED's - Package Includes Light, LDM 1050, and 4 Meter Cable	<b>\$1200</b>	<b>365 + \$150</b> UV 365nm <b>395 + \$150</b> UV 395nm <b>470 + \$0</b> Blue <b>530 + \$0</b> Green <b>630 + \$0</b> Red <b>850 + \$150</b> Infrared <b>940 + \$225</b> Infrared <b>WHI + \$0</b> White <b>NWH + \$0</b> Neutral White	<b>12 + \$0</b> 12 Degree <b>16 + \$0</b> 16 Frosted <b>23 + \$0</b> 23 Frosted <b>30 + \$0</b> 30 Frosted <b>39 + \$0</b> 39 Frosted <b>50 + \$0</b> 50 Degree <b>F + \$0</b> Wide Angle <b>R + \$0</b> Reflector 90 <b>L + \$0</b> Line	<b>SD + \$0</b> Standard <b>CC + \$0</b> Clear Cover <b>TFD + \$25</b> Thin Film <b>WD + \$0</b> White <b>P + \$50</b> Polarizer <b>UVCC + \$0</b> UV Clear Cover	<b>LDM700 + \$0</b> 700mA Driver <b>A + \$85</b> ALDM Driver <b>V + \$85</b> VLDM Driver <b>RV + \$100</b> RVLDM Driver	<b>MC4 + \$0</b> 4 meter <b>MC8 + \$20</b> 8 meter <b>MC15 + \$60</b> 15 meter <b>MC30 *</b> 30 meter <b>MCHF4 + \$35</b> High Flex 4 meter <b>MCHF8 + \$60</b> High Flex 8 meter <b>MCHF15 *</b> High Flex 15 meter <b>MCHF30 *</b> High Flex 30 meter
---	---------------	--	--	--	--	--

Dimensions: W 2.5" L 18.25" H 1.25" Wgt 2.6 lbs

(\*) Call for pricing

Monster-Series Linear Lights

1 Base Part Number	List Price	2 LED	3 Lens	4 Diffuser	5 Driver	6 Cable
<b>MLL123</b> 23" Linear Light LED's - Package Includes Light, LDM 1400, and 4 Meter Cable	<b>\$1400</b>	<b>365 + \$200</b> UV 365nm <b>395 + \$200</b> UV 395nm <b>470 + \$0</b> Blue <b>530 + \$0</b> Green <b>630 + \$0</b> Red <b>850 + \$200</b> Infrared <b>940 + \$300</b> Infrared <b>WHI + \$0</b> White <b>NWH + \$0</b> Neutral White	<b>12 + \$0</b> 12 Degree <b>16 + \$0</b> 16 Frosted <b>23 + \$0</b> 23 Frosted <b>30 + \$0</b> 30 Frosted <b>39 + \$0</b> 39 Frosted <b>50 + \$0</b> 50 Degree <b>F + \$0</b> Wide Angle <b>R + \$0</b> Reflector 90 <b>L + \$0</b> Line	<b>SD + \$0</b> Standard <b>CC + \$0</b> Clear Cover <b>TFD + \$50</b> Thin Film <b>WD + \$0</b> White <b>P + \$75</b> Polarizer <b>UVCC + \$0</b> UV Clear Cover	<b>LDM1400 + \$0</b> 31400mA Driver <b>A + \$85</b> ALDM Driver <b>V + \$85</b> VLDM Driver <b>RV + \$100</b> RVLDM Driver	<b>MC4 + \$0</b> 4 meter <b>MC8 + \$20</b> 8 meter <b>MC15 + \$60</b> 15 meter <b>MC30 *</b> 30 meter <b>MCHF4 + \$35</b> High Flex 4 meter <b>MCHF8 + \$60</b> High Flex 8 meter <b>MCHF15 *</b> High Flex 15 meter <b>MCHF30 *</b> High Flex 30 meter

Dimensions: W 2.5" L 24" H 1.25" Wgt 3.45 lbs

(\*) Call for pricing

<b>MLL128.75</b> 28.75" Linear Light LED's - Package Includes Light, LDM 1750, and 4 Meter Cable	<b>\$1650</b>	<b>365 + \$250</b> UV 365nm <b>395 + \$250</b> UV 395nm <b>470 + \$0</b> Blue <b>530 + \$0</b> Green <b>630 + \$0</b> Red <b>850 + \$250</b> Infrared <b>940 + \$375</b> Infrared <b>WHI + \$0</b> White <b>NWH + \$0</b> Neutral White	<b>12 + \$0</b> 12 Degree <b>16 + \$0</b> 16 Frosted <b>23 + \$0</b> 23 Frosted <b>30 + \$0</b> 30 Frosted <b>39 + \$0</b> 39 Frosted <b>50 + \$0</b> 50 Degree <b>F + \$0</b> Wide Angle <b>R + \$0</b> Reflector 90 <b>L + \$0</b> Line	<b>SD + \$0</b> Standard <b>CC + \$0</b> Clear Cover <b>TFD + \$50</b> Thin Film <b>WD + \$0</b> White <b>P + \$100</b> Polarizer <b>UVCC + \$0</b> UV Clear Cover	<b>LDM1750 + \$0</b> 1750mA Driver <b>A + \$85</b> ALDM Driver <b>V + \$85</b> VLDM Driver <b>RV + \$100</b> RVLDM Driver	<b>MC4 + \$0</b> 4 meter <b>MC8 + \$20</b> 8 meter <b>MC15 + \$60</b> 15 meter <b>MC30 *</b> 30 meter <b>MCHF4 + \$35</b> High Flex 4 meter <b>MCHF8 + \$60</b> High Flex 8 meter <b>MCHF15 *</b> High Flex 15 meter <b>MCHF30 *</b> High Flex 30 meter
--	---------------	--	--	---	--	--

Dimensions: W 2.5" L 29.75" H 1.25" Wgt 4.4 lbs

(\*) Call for pricing

<b>MLL134.5</b> 34.5" Linear Light LED's - Package Includes Light, LDM 2100, and 4 Meter Cable	<b>\$2000</b>	<b>365 + \$300</b> UV 365nm <b>395 + \$300</b> UV 395nm <b>470 + \$0</b> Blue <b>530 + \$0</b> Green <b>630 + \$0</b> Red <b>850 + \$300</b> Infrared <b>940 + \$450</b> Infrared <b>WHI + \$0</b> White <b>NWH + \$0</b> Neutral White	<b>12 + \$0</b> 12 Degree <b>16 + \$0</b> 16 Frosted <b>23 + \$0</b> 23 Frosted <b>30 + \$0</b> 30 Frosted <b>39 + \$0</b> 39 Frosted <b>50 + \$0</b> 50 Degree <b>F + \$0</b> Wide Angle <b>R + \$0</b> Reflector 90 <b>L + \$0</b> Line	<b>SD + \$0</b> Standard <b>CC + \$0</b> Clear Cover <b>TFD + \$50</b> Thin Film <b>WD + \$0</b> White <b>P + \$100</b> Polarizer <b>UVCC + \$0</b> UV Clear Cover	<b>LDM2100 + \$0</b> 2100mA Driver <b>A + \$85</b> ALDM Driver <b>V + \$85</b> VLDM Driver <b>RV + \$100</b> RVLDM Driver	<b>MC4 + \$0</b> 4 meter <b>MC8 + \$20</b> 8 meter <b>MC15 + \$60</b> 15 meter <b>MC30 *</b> 30 meter <b>MCHF4 + \$35</b> High Flex 4 meter <b>MCHF8 + \$60</b> High Flex 8 meter <b>MCHF15 *</b> High Flex 15 meter <b>MCHF30 *</b> High Flex 30 meter
--	---------------	--	--	---	--	--

Dimensions: W 2.5" L 35.5" H 1.25" Wgt 5 lbs

(\*) Call for pricing

Monster-Series Linear Lights

1	2	3	4	5	6	
Base Part Number	List Price	LED	Lens	Diffuser	Driver	Cable
<b>MLL146</b> 46" Linear Light LED's - Package Includes Light, LDM 2800, and 4 Meter Cable	<b>\$3250</b>	<b>365 + \$400</b> UV 365nm <b>395 + \$400</b> UV 395nm <b>470 + \$0</b> Blue <b>530 + \$0</b> Green <b>630 + \$0</b> Red <b>850 + \$400</b> Infrared <b>940 + \$600</b> Infrared <b>WHI + \$0</b> White <b>NWH + \$0</b> Neutral White	<b>12 + \$0</b> 12 Degree <b>16 + \$0</b> 16 Frosted <b>23 + \$0</b> 23 Frosted <b>30 + \$0</b> 30 Frosted <b>39 + \$0</b> 39 Frosted <b>50 + \$0</b> 50 Degree <b>F + \$0</b> Wide Angle <b>R + \$0</b> Reflector 90 <b>L + \$0</b> Line	<b>SD + \$0</b> Standard <b>CC + \$0</b> Clear Cover <b>TFD + \$75</b> Thin Film <b>WD + \$0</b> White <b>P + \$175</b> Polarizer <b>UVCC + \$0</b> UV Clear Cover	<b>LDM2800 + \$0</b> 2800mA Driver <b>A + \$85</b> ALDM Driver <b>V + \$85</b> VLDM Driver <b>RV + \$100</b> RVLDM Driver	<b>MC4 + \$0</b> 4 meter <b>MC8 + \$20</b> 8 meter <b>MC15 + \$60</b> 15 meter <b>MC30 *</b> 30 meter <b>MCHF4 + \$35</b> High Flex 4 meter <b>MCHF8 + \$60</b> High Flex 8 meter <b>MCHF15 *</b> High Flex 15 meter <b>MCHF30 *</b> High Flex 30 meter

Dimensions: W 3.8" L 49.25" H 3.5" Wgt 14.2 lbs

(\*) Call for pricing

<b>MLL157.5</b> 57.5" Linear Light LED's - Package Includes Light, LDM 3500, and 4 Meter Cable	<b>\$3750</b>	<b>365 + \$500</b> UV 365nm <b>395 + \$500</b> UV 395nm <b>470 + \$0</b> Blue <b>530 + \$0</b> Green <b>630 + \$0</b> Red <b>850 + \$500</b> Infrared <b>940 + \$750</b> Infrared <b>WHI + \$0</b> White <b>NWH + \$0</b> Neutral White	<b>12 + \$0</b> 12 Degree <b>16 + \$0</b> 16 Frosted <b>23 + \$0</b> 23 Frosted <b>30 + \$0</b> 30 Frosted <b>39 + \$0</b> 39 Frosted <b>50 + \$0</b> 50 Degree <b>F + \$0</b> Wide Angle <b>R + \$0</b> Reflector 90 <b>L + \$0</b> Line	<b>SD + \$0</b> Standard <b>CC + \$0</b> Clear Cover <b>TFD + \$100</b> Thin Film <b>WD + \$0</b> White <b>P + \$200</b> Polarizer <b>UVCC + \$0</b> UV Clear Cover	<b>LDM3500 + \$0</b> 3500mA Driver <b>A + \$85</b> ALDM Driver <b>V + \$85</b> VLDM Driver <b>RV + \$100</b> RVLDM Driver	<b>MC4 + \$0</b> 4 meter <b>MC8 + \$20</b> 8 meter <b>MC15 + \$60</b> 15 meter <b>MC30 *</b> 30 meter <b>MCHF4 + \$35</b> High Flex 4 meter <b>MCHF8 + \$60</b> High Flex 8 meter <b>MCHF15 *</b> High Flex 15 meter <b>MCHF30 *</b> High Flex 30 meter
--	---------------	--	--	--	--	--

Dimensions: W 3.8" L 60.75" H 3.5" Wgt 17.35 lbs

(\*) Call for pricing

<b>MLL169</b> 69" Linear Light LED's - Package Includes Light, LDM 4200, and 4 Meter Cable	<b>\$4300</b>	<b>365 + \$600</b> UV 365nm <b>395 + \$600</b> UV 395nm <b>470 + \$0</b> Blue <b>530 + \$0</b> Green <b>630 + \$0</b> Red <b>850 + \$600</b> Infrared <b>940 + \$900</b> Infrared <b>WHI + \$0</b> White <b>NWH + \$0</b> Neutral White	<b>12 + \$0</b> 12 Degree <b>16 + \$0</b> 16 Frosted <b>23 + \$0</b> 23 Frosted <b>30 + \$0</b> 30 Frosted <b>39 + \$0</b> 39 Frosted <b>50 + \$0</b> 50 Degree <b>F + \$0</b> Wide Angle <b>R + \$0</b> Reflector 90 <b>L + \$0</b> Line	<b>SD + \$0</b> Standard <b>CC + \$0</b> Clear Cover <b>UVCC + \$0</b> UV Clear Cover <b>WD + \$0</b> White	<b>LDM4200 + \$0</b> 4200mA Driver <b>A + \$85</b> ALDM Driver <b>V + \$85</b> VLDM Driver <b>RV + \$100</b> RVLDM Driver	<b>MC4-HO/6 + \$0</b> High Output 4 m <b>MC8-HO/6 *</b> High Output 8 m <b>MC15-HO/6 *</b> High Output 15 m <b>MC30-HO/6 *</b> High Output 30 m <b>MCHF4-HO/6 *</b> High Flex 4 m <b>MCHF8-HO/6 *</b> High Flex 8m <b>MCHF15-HO/6 *</b> High Flex 15m <b>MCHF30-HO/6 *</b> High Flex 30m
--	---------------	--	--	--	--	---

Dimensions: W 3.8" L 72.25" H 3.5" Wgt 17.35 lbs

(\*) Call for pricing

Monster-Series Linear Lights

1	2	3	4	5	6	
Base Part Number	List Price	LED	Lens	Diffuser	Driver	Cable
<b>MLL180.5</b> 80.5" Linear Light LED - Package Includes Light, LDM 4900, and 4 Meter Cable	<b>\$4850</b>	<b>365 + \$700</b> UV 365nm <b>395 + \$700</b> UV 395nm <b>470 + \$0</b> Blue <b>530 + \$0</b> Green <b>630 + \$0</b> Red <b>850 + \$700</b> Infrared <b>940 + \$1050</b> Infrared <b>WHI + \$0</b> White <b>NWH + \$0</b> Neutral White	<b>12 + \$0</b> 12 Degree <b>16 + \$0</b> 16 Frosted <b>23 + \$0</b> 23 Frosted <b>30 + \$0</b> 30 Frosted <b>39 + \$0</b> 39 Frosted <b>50 + \$0</b> 50 Degree <b>F + \$0</b> Wide Angle <b>R + \$0</b> Reflector 90 <b>L + \$0</b> Line	<b>SD + \$0</b> Standard <b>CC + \$0</b> Clear Cover <b>UVCC + \$0</b> UV Clear <b>WD + \$0</b> White	<b>LDM4900 + \$0</b> 4900mA Driver <b>A + \$85</b> ALDM Driver <b>V + \$85</b> VLDM Driver <b>RV + \$100</b> RVLDM Driver	<b>MC4-HO/6 + \$0</b> High Output 4 m <b>MC8-HO/6 *</b> High Output 8 m <b>MC15-HO/6 *</b> High Output 15 m <b>MC30-HO/6 *</b> High Output 30 m <b>MCHF4-HO/6 *</b> High Flex 4 m <b>MCHF8-HO/6 *</b> High Flex 8m <b>MCHF15-HO/6 *</b> High Flex 15m <b>MCHF30-HO/6 *</b> High Flex 30m

Dimensions: W 3.8" L 83.75" H 3.5" Wgt lbs

(\*) Call for pricing

<b>MLL22</b> 2" X 2" Linear Light LED - Package Includes Light, LDM 700, and 4 Meter Cable	<b>\$750</b>	<b>365 + \$20</b> UV 365nm <b>395 + \$20</b> UV 395nm <b>470 + \$0</b> Blue <b>530 + \$0</b> Green <b>630 + \$0</b> Red <b>850 + \$20</b> Infrared <b>WHI + \$0</b> White <b>NWH + \$0</b> Neutral White	<b>12 + \$0</b> 12 Degree <b>16 + \$0</b> 16 Frosted <b>23 + \$0</b> 23 Frosted <b>30 + \$0</b> 30 Frosted <b>39 + \$0</b> 39 Frosted <b>50 + \$0</b> 50 Degree <b>F + \$0</b> Wide Angle <b>R + \$0</b> Reflector 90 <b>L + \$0</b> Line	<b>SD + \$0</b> Standard <b>CC + \$0</b> Clear Cover <b>TFD + \$25</b> Thin Film <b>WD + \$0</b> White <b>P + \$25</b> Polarizer <b>UVCC + \$0</b> UV Clear Cover	<b>LDM700 + \$0</b> 700mA Driver <b>A + \$85</b> ALDM Driver <b>V + \$85</b> VLDM Driver <b>RV + \$100</b> RVLDM Driver	<b>MC4 + \$0</b> 4 meter <b>MC8 + \$20</b> 8 meter <b>MC15 + \$60</b> 15 meter <b>MC30 *</b> 30 meter <b>MCHF4 + \$35</b> High Flex 4 meter <b>MCHF8 + \$60</b> High Flex 8 meter <b>MCHF15 *</b> High Flex 15 meter <b>MCHF30 *</b> High Flex 30 meter
---	--------------	---	--	--	--	--

Dimensions: W 3" L 3" H 1.125" Wgt lbs

(\*) Call for pricing

<b>MLL24</b> 2" x 4" Linear Light LED - Package Includes Light, LDM 700, and 4 Meter Cable	<b>\$900</b>	<b>365 + \$50</b> UV 365nm <b>395 + \$50</b> UV 395nm <b>470 + \$0</b> Blue <b>530 + \$0</b> Green <b>630 + \$0</b> Red <b>850 + \$50</b> Infrared <b>WHI + \$0</b> White <b>NWH + \$0</b> Neutral White	<b>12 + \$0</b> 12 Degree <b>16 + \$0</b> 16 Frosted <b>23 + \$0</b> 23 Frosted <b>30 + \$0</b> 30 Frosted <b>39 + \$0</b> 39 Frosted <b>50 + \$0</b> 50 Degree <b>F + \$0</b> Wide Angle <b>R + \$0</b> Reflector 90 <b>L + \$0</b> Line	<b>SD + \$0</b> Standard <b>CC + \$0</b> Clear Cover <b>TFD + \$25</b> Thin Film <b>WD + \$0</b> White <b>P + \$25</b> Polarizer <b>UVCC + \$0</b> UV Clear Cover	<b>LDM700 + \$0</b> 700mA Driver <b>A + \$85</b> ALDM Driver <b>V + \$85</b> VLDM Driver <b>RV + \$100</b> RVLDM Driver	<b>MC4 + \$0</b> 4 meter <b>MC8 + \$20</b> 8 meter <b>MC15 + \$60</b> 15 meter <b>MC30 *</b> 30 meter <b>MCHF4 + \$35</b> High Flex 4 meter <b>MCHF8 + \$60</b> High Flex 8 meter <b>MCHF15 *</b> High Flex 15 meter <b>MCHF30 *</b> High Flex 30 meter
---	--------------	---	--	--	--	--

Dimensions: W 3" L 5" H 1.125" Wgt lbs

(\*) Call for pricing

Monster-Series Linear Lights

1 Base Part Number	List Price	2 LED	3 Lens	4 Diffuser	5 Driver	6 Cable
<b>MLL26</b> 2" X 6" Linear Light LED's - Package Includes Light, LDM 700, and 4 Meter Cable	<b>\$1000</b>	<b>365 + \$75</b> UV 365nm <b>395 + \$75</b> UV 395nm <b>470 + \$0</b> Blue <b>530 + \$0</b> Green <b>630 + \$0</b> Red <b>850 + \$75</b> Infrared <b>WHI + \$0</b> White <b>NWH + \$0</b> Neutral White	<b>12 + \$0</b> 12 Degree <b>16 + \$0</b> 16 Frosted <b>23 + \$0</b> 23 Frosted <b>30 + \$0</b> 30 Frosted <b>39 + \$0</b> 39 Frosted <b>50 + \$0</b> 50 Degree <b>F + \$0</b> Wide Angle <b>R + \$0</b> Reflector 90 <b>L + \$0</b> Line	<b>SD + \$0</b> Standard <b>CC + \$0</b> Clear Cover <b>TFD + \$25</b> Thin Film <b>WD + \$0</b> White <b>P + \$25</b> Polarizer <b>UVCC + \$0</b> UV Clear Cover	<b>LDM700 + \$0</b> 700mA Driver <b>A + \$85</b> ALDM Driver <b>V + \$85</b> VLDM Driver <b>RV + \$100</b> RVLDM Driver	<b>MC4 + \$0</b> 4 meter <b>MC8 + \$20</b> 8 meter <b>MC15 + \$60</b> 15 meter <b>MC30 *</b> 30 meter <b>MCHF4 + \$35</b> High Flex 4 meter <b>MCHF8 + \$60</b> High Flex 8 meter <b>MCHF15 *</b> High Flex 15 meter <b>MCHF30 *</b> High Flex 30 meter
Dimensions: W 3.25" L 7.25" H 1.25" Wgt 1.25 lbs				(*) Call for pricing		

<b>MLL44</b> 4" x 4" Linear Light LED - Package Includes Light, LDM 1400, and 4 Meter Cable	<b>\$1350</b>	<b>365 + \$100</b> UV 365nm <b>395 + \$100</b> UV 395nm <b>470 + \$0</b> Blue <b>530 + \$0</b> Green <b>630 + \$0</b> Red <b>850 + \$100</b> Infrared <b>WHI + \$0</b> White <b>NWH + \$0</b> Neutral White	<b>12 + \$0</b> 12 Degree <b>16 + \$0</b> 16 Frosted <b>23 + \$0</b> 23 Frosted <b>30 + \$0</b> 30 Frosted <b>39 + \$0</b> 39 Frosted <b>50 + \$0</b> 50 Degree <b>F + \$0</b> Wide Angle <b>R + \$0</b> Reflector 90 <b>L + \$0</b> Line	<b>SD + \$0</b> Standard <b>CC + \$0</b> Clear Cover <b>TFD + \$25</b> Thin Film <b>WD + \$0</b> White <b>P + \$35</b> Polarizer <b>UVCC + \$0</b> UV Clear Cover	<b>LDM1400 + \$0</b> 1400mA Driver <b>A + \$85</b> ALDM Driver <b>V + \$85</b> VLDM Driver <b>RV + \$100</b> RVLDM Driver	<b>MC4 + \$0</b> 4 meter <b>MC8 + \$20</b> 8 meter <b>MC15 + \$60</b> 15 meter <b>MC30 *</b> 30 meter <b>MCHF4 + \$35</b> High Flex 4 meter <b>MCHF8 + \$60</b> High Flex 8 meter <b>MCHF15 *</b> High Flex 15 meter <b>MCHF30 *</b> High Flex 30 meter
Dimensions: W 5" L 5" H 1" Wgt lbs				(*) Call for pricing		

<b>MLL46</b> 4" x 6" Linear Light LED - Package Includes Light, LDM 2100, and 4 Meter Cable	<b>\$1650</b>	<b>365 + \$150</b> UV 365nm <b>395 + \$150</b> UV 395nm <b>470 + \$0</b> Blue <b>530 + \$0</b> Green <b>630 + \$0</b> Red <b>850 + \$150</b> Infrared <b>WHI + \$0</b> White <b>NWH + \$0</b> Neutral White	<b>12 + \$0</b> 12 Degree <b>16 + \$0</b> 16 Frosted <b>23 + \$0</b> 23 Frosted <b>30 + \$0</b> 30 Frosted <b>39 + \$0</b> 39 Frosted <b>50 + \$0</b> 50 Degree <b>F + \$0</b> Wide Angle <b>R + \$0</b> Reflector 90 <b>L + \$0</b> Line	<b>SD + \$0</b> Standard <b>CC + \$0</b> Clear Cover <b>TFD + \$25</b> Thin Film <b>WD + \$0</b> White <b>P + \$25</b> Polarizer <b>UVCC + \$0</b> UV Clear Cover	<b>LDM2100 + \$0</b> 2100mA Driver <b>A + \$85</b> ALDM Driver <b>V + \$85</b> VLDM Driver <b>RV + \$100</b> RVLDM Driver	<b>MC4 + \$0</b> 4 meter <b>MC8 + \$20</b> 8 meter <b>MC15 + \$60</b> 15 meter <b>MC30 *</b> 30 meter <b>MCHF4 + \$35</b> High Flex 4 meter <b>MCHF8 + \$60</b> High Flex 8 meter <b>MCHF15 *</b> High Flex 15 meter <b>MCHF30 *</b> High Flex 30 meter
Dimensions: W 5" L 7" H 1" Wgt lbs				LED Optics Line (*) Call for pricing		

Monster-Series Linear Lights

1 Base Part Number	List Price	2 LED	3 Lens	4 Diffuser	5 Driver	6 Cable
<b>MLL48</b> 4" x 8" Linear Light LED - Package Includes Light, LDM 2800, and 4 Meter Cable	<b>\$2150</b>	<b>365 + \$250</b> UV 365nm <b>395 + \$250</b> UV 395nm <b>470 + \$0</b> Blue <b>530 + \$0</b> Green <b>630 + \$0</b> Red <b>850 + \$250</b> Infrared <b>WHI + \$0</b> White <b>NWH + \$0</b> Neutral White	<b>12 + \$0</b> 12 Degree <b>16 + \$0</b> 16 Frosted <b>23 + \$0</b> 23 Frosted <b>30 + \$0</b> 30 Frosted <b>39 + \$0</b> 39 Frosted <b>50 + \$0</b> 50 Degree <b>F + \$0</b> Wide Angle <b>R + \$0</b> Reflector 90 <b>L + \$0</b> Line	<b>SD + \$0</b> Standard <b>CC + \$0</b> Clear Cover <b>TFD + \$25</b> Thin Film <b>WD + \$0</b> White <b>P + \$40</b> Polarizer <b>UVCC + \$0</b> UV Clear Cover	<b>LDM2800 + \$0</b> 2800mA Driver <b>A + \$85</b> ALDM Driver <b>V + \$85</b> VLDM Driver <b>RV + \$100</b> RVLDM Driver	<b>MC4 + \$0</b> 4 meter <b>MC8 + \$20</b> 8 meter <b>MC15 + \$60</b> 15 meter <b>MC30 *</b> 30 meter <b>MCHF4 + \$35</b> High Flex 4 meter <b>MCHF8 + \$60</b> High Flex 8 meter <b>MCHF15 *</b> High Flex 15 meter <b>MCHF30 *</b> High Flex 30 meter
Dimensions: W 5" L 9" H 1.25" Wgt lbs				(*) Call for pricing		

Back  
Lights

Diffused  
Axial

Dome  
Lights

Linear  
Lights

Oxy Lights

Ring Lights

Spot Lights

Washdown  
Lights

Controllers  
& Cables

Back  
Lights

Diffused  
Axial

Dome  
Lights

Linear  
Lights

Oxy Lights

Ring Lights

Spot Lights

Washdown  
Lights

Controllers  
& Cables

### Monster-Series Linear Lights with Internal Driver

- Features:
- Internal Driver Built-in/controller included
  - Auto Burst Technology
  - High Power LED's (24 VDC)
  - Multi Zone LED control
  - M12 connector for quick disconnect
  - Available in 8 colors, Ultra-Violet, and Infrared
  - Available in 4 sizes
  - 0 - 10 VDC intensity Control
  - Potentiometer Intensity Control
  - 10 Year Warranty\* - 100,000 hours



To Order, Specify;

1 Base Part Number	2 LED Color	3 Lens Type	4 Diffuser	5 Cable Option
EL300	470	16	CC	EC5
\$750	\$0	\$0	\$0	\$20

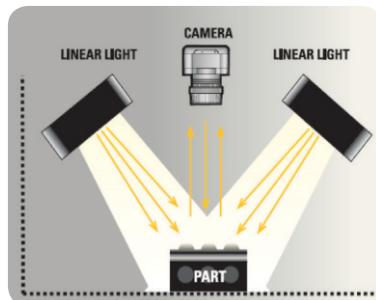

Bar Lights, also known as Linear Array Lights, offer both bright field and dark field illumination, depending on angle of incidence with respect to the object of interest.

#### Application Example

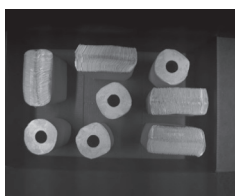

Object: Packaging Inspection. Image captured shows high contrast package parts. Checking for presence or absence and orientation.

### Monster-Series Linear Lights with Internal Driver

1 Base Part Number	List Price	2 LED	3 LensType	4 Diffuser	5 Cable
MLLD16 6" Linear Light LED - Package Includes Light and 3 Meter Cable	\$675	365 + \$50 Ultraviolet 365nm	12 + \$0 12 Degree	SD + \$0 Standard Diffuser	EC3 + \$0 3 Meter
		395 + \$50 Ultraviolet 395nm	16 + \$0 16 Frosted	CC + \$0 Clear Cover	EC5 + \$20 5 Meter
		470 + \$0 Blue	23 + \$0 23 Frosted	TFD + \$25 Thin Film Diffuser	
		530 + \$0 Green	30 + \$0 30 Frosted	WD + \$0 White Diffuser	
		630 + \$0 Red	39 + \$0 39 Frosted	P + \$25 Polarizer	
		850 + \$50 Infrared	50 + \$0 50 Degree	UVCC + \$0 UV Clear Cover	
		940 + \$75 Infrared	F + \$0 Wide Angle		
		WHI + \$0 White	R + \$0 Reflector 90		
		NWH + \$0 Neutral White	L + \$0 Line		
		Dimensions: W 2.25" L 6.5" H 1.125" Wgt .8 lbs (*) Call for pricing			
MLLD111.5 11.5" Linear Light LED - Package Includes Light and 3 Meter Cable	\$800	365 + \$100 Ultraviolet 365nm	12 + \$0 12 Degree	SD + \$0 Standard Diffuser	EC3 + \$0 3 Meter
		395 + \$100 Ultraviolet 395nm	16 + \$0 16 Frosted	CC + \$0 Clear Cover	EC5 + \$20 5 Meter
		470 + \$0 Blue	23 + \$0 23 Frosted	TFD + \$25 Thin Film Diffuser	
		530 + \$0 Green	30 + \$0 30 Frosted	WD + \$0 White Diffuser	
		630 + \$0 Red	39 + \$0 39 Frosted	P + \$25 Polarizer	
		850 + \$100 Infrared	50 + \$0 50 Degree	UVCC + \$0 UV Clear Cover	
		940 + \$150 Infrared	F + \$0 Wide Angle		
		WHI + \$0 White	R + \$0 Reflector 90		
		NWH + \$0 Neutral White	L + \$0 Line		
		Dimensions: W 2.5" L 13" H 1.125" Wgt .8 lbs (*) Call for pricing			
MLLD111.5-xxx-yyy 11.5" Linear Light LED - Package Includes Light and (2) 3 Meter Cable	Call for Pricing	365 + Ultraviolet 365nm	12 + \$0 12 Degree	SD + \$0 Standard Diffuser	EC3 + 3 Meter
		395 + Ultraviolet 395nm	16 + \$0 16 Frosted	CC + \$0 Clear Cover	EC5 + 5 Meter
		470 + Blue	23 + \$0 23 Frosted	TFD + \$25 Thin Film Diffuser	
		530 + Green	30 + \$0 30 Frosted	WD + \$0 White Diffuser	
		630 + Red	39 + \$0 39 Frosted	P + \$25 Polarizer	
		850 + Infrared	50 + \$0 50 Degree	UVCC + \$0 UV Clear Cover	
		940 + Infrared	F + \$0 Wide Angle		
		WHI + White	R + \$0 Reflector 90		
		NWH + Neutral White	L + \$0 Line		
		Dimensions: W 2.5" L 13" H 1.125" Wgt 1.1 lbs (*) Call for pricing			

Monster-Series Linear Lights with Internal Driver

1 Base Part Number	List Price	2 LED	3 LensType	4 Diffuser	5 Cable
<b>MLLD117.5</b> 17.25" Linear Light LED - Package Includes Light and 3 Meter Cable	<b>\$1225</b>	<b>365 + \$150</b> Ultraviolet 365nm <b>395 + \$150</b> Ultraviolet 395nm <b>470 + \$0</b> Blue <b>530 + \$0</b> Green <b>630 + \$0</b> Red <b>850 + \$150</b> Infrared <b>940 + \$225</b> Infrared <b>WHI + \$0</b> White <b>NWH + \$0</b> Neutral White	<b>12 + \$0</b> 12 Degree <b>16 + \$0</b> 16 Frosted <b>23 + \$0</b> 23 Frosted <b>30 + \$0</b> 30 Frosted <b>39 + \$0</b> 39 Frosted <b>50 + \$0</b> 50 Degree <b>F + \$0</b> Wide Angle <b>R + \$0</b> Reflector 90 <b>L + \$0</b> Line	<b>SD + \$0</b> Standard Diffuser <b>CC + \$0</b> Clear Cover <b>TFD + \$25</b> Thin Film Diffuser <b>WD + \$0</b> White Diffuser <b>P + \$50</b> Polarizer <b>UVCC + \$0</b> UV Clear Cover	<b>EC3 + \$0</b> 3 Meter <b>EC5 + \$20</b> 5 Meter
Dimensions: W 2.5" L 18.5" H 1.25" Wgt 2.6 lbs		(*) Call for pricing			

<b>MLLD123</b> 23" Linear Light LED - Package Includes Light and 3 Meter Cable	<b>\$1425</b>	<b>365 + \$200</b> Ultraviolet 365nm <b>395 + \$200</b> Ultraviolet 395nm <b>470 + \$0</b> Blue <b>530 + \$0</b> Green <b>630 + \$0</b> Red <b>850 + \$200</b> Infrared <b>940 + \$300</b> Infrared <b>WHI + \$0</b> White <b>NWH + \$0</b> Neutral White	<b>12 + \$0</b> 12 Degree <b>16 + \$0</b> 16 Frosted <b>23 + \$0</b> 23 Frosted <b>30 + \$0</b> 30 Frosted <b>39 + \$0</b> 39 Frosted <b>50 + \$0</b> 50 Degree <b>F + \$0</b> Wide Angle <b>R + \$0</b> Reflector 90 <b>L + \$0</b> Line	<b>SD + \$0</b> Standard Diffuser <b>CC + \$0</b> Clear Cover <b>TFD + \$50</b> Thin Film Diffuser <b>WD + \$0</b> White Diffuser <b>P + \$75</b> Polarizer <b>UVCC + \$0</b> UV Clear Cover	<b>EC3 + \$0</b> 3 Meter <b>EC5 + \$20</b> 5 Meter
Dimensions: W 2.5" L 18.5" H 1.25" Wgt 2.6 lbs		(*) Call for pricing			

Monster-Series Xtreme Linear Lights

Features:

- Internal driver/controller included
- Auto Burst 3.5x Technology
- Ultra-High Power LED's (24 VDC)
- 6 pin male connector
- 6 pin female tension connector
- PNP and NPN inputs
- Thermal Protection
- Modular end-to-end design
- Available in 2 colors
- Available in 2 sizes and 40mm Spot Light
- 10 Year Warranty\* - 100,000 hours

To Order, Specify;

<b>1</b> Base Part Number	<b>XL2150</b>
Example:	<b>\$1000</b>
<b>2</b> Specify LED Color	<b>WHI</b> <b>+ \$0</b>
<b>3</b> Specify Lens Type	<b>16</b> <b>+ \$0</b>
<b>4</b> Specify Diffuser Type	<b>CC</b> <b>+ \$0</b>

1 Base Part Number	List Price	2 LED Color	3 Lens Type	4 Diffuser Type
<b>XL2150</b> Xtreme Series Double Row 150mm Bar Light With White LED's	<b>\$1000</b>	<b>WHI + \$0</b> White <b>NWH + \$0</b> Neutral White	<b>16 + \$0</b> LED Optics 16 Frosted <b>23 + \$0</b> LED Optics 23 Frosted <b>39 + \$0</b> LED Optics 39 Frosted <b>R + \$0</b> LED Reflector 90 <b>L + \$0</b> LED Optics Line	<b>CC + \$0</b> Clear Cover <b>SD + \$0</b> Standard Diffuser <b>TFD + \$25</b> Thin Film Diffuser <b>WD + \$0</b> White Diffuser
Dimensions: W 3.842" L 5.886" H 1.2" Wgt .8 lbs		(*) Call for pricing		

<b>XL300</b> Xtreme Series 300mm Bar Light With White LED's	<b>\$1100</b>	<b>WHI + \$0</b> White <b>NWH + \$0</b> Neutral White	<b>16 + \$0</b> LED Optics 16 Frosted <b>23 + \$0</b> LED Optics 23 Frosted <b>39 + \$0</b> LED Optics 39 Frosted <b>R + \$0</b> LED Reflector 90 <b>L + \$0</b> LED Optics Line	<b>CC + \$0</b> Clear Cover <b>SD + \$0</b> Standard Diffuser <b>TFD + \$25</b> Thin Film Diffuser <b>WD + \$0</b> White Diffuser
Dimensions: W 2.675" L 11.791" H 1.188" Wgt .8 lbs		(*) Call for pricing		

## Oxy Lights

Standard-Series Oxy (Flat Dome) Lights - No Driver Required 51

## Standard-Series Oxy Lights

Features:

- No driver/controller required
- HS (High Speed) Strobe Technology
- 24 VDC
- M12 connector for quick disconnect
- Available in 2 colors and Infrared
- Available in 2 sizes
- 10 Year Warranty\* - 100,000 hours

### To Order, Specify;

1 Base Part Number	<b>OL66</b>
Example:	<b>\$1000</b>
2 Specify LED Color	<b>630 + \$0</b>
3 Specify Diffuser Type	<b>SD + \$0</b>
4 Specify Cable Option	<b>SC4 + \$0</b>

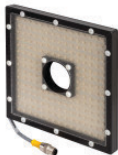
1 Base Part Number	List Price	2 LED Color	3 Diffuser Type	4 Cable Option
<b>OL66</b> 6" X 6" Oxy Ring Light LEDs - Package Includes Light, and 4 Meter Cable 	<b>\$1000</b>	<b>630 + \$0</b> Red <b>880 + \$250</b> Infrared <b>950 + \$250</b> Infrared <b>WHI + \$0</b> White	<b>SD + \$0</b> Standard Diffuser <b>TFD + \$25</b> Thin Film Diffuser <b>WD + \$0</b> White Diffuser <b>P + \$50</b> Polarizer	<b>SC4 + \$0</b> Standard Cable 4 meter <b>SC8 + \$50</b> Standard Cable 8 meter <b>SC15 + \$85</b> Standard Cable 15 meter <b>SC30 *</b> Standard Cable 30 meter <b>SCHF4 + \$35</b> Standard High Flex Cable 4 meter <b>SCHF8 + \$60</b> Standard High Flex Cable 8 meter <b>SCHF15 + \$160</b> Standard High Flex Cable 15 meter
Dimensions: W 7" L 7" H .775" Wgt 1.5 lbs				(*) Call for pricing

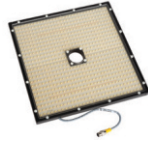
<b>OL1212</b> 12" X 12" Oxy Ring Light LEDs - Package Includes Light, and 4 Meter Cable 	<b>\$1500</b>	<b>630 + \$0</b> Red <b>880 + \$350</b> Infrared <b>950 + \$350</b> Infrared <b>WHI + \$0</b> White	<b>SD + \$0</b> Standard Diffuser <b>TFD + \$50</b> Thin Film Diffuser <b>WD + \$0</b> White Diffuser <b>P + \$165</b> Polarizer	<b>SC4 + \$0</b> Standard Cable 4 meter <b>SC8 + \$50</b> Standard Cable 8 meter <b>SC15 + \$85</b> Standard Cable 15 meter <b>SC30 *</b> Standard Cable 30 meter <b>SCHF4 + \$35</b> Standard High Flex Cable 4 meter <b>SCHF8 + \$60</b> Standard High Flex Cable 8 meter <b>SCHF15 + \$160</b> Standard High Flex Cable 15 meter
Dimensions: W 13" L 13" H .775" Wgt 4.45 lbs				(*) Call for pricing

\*Call for pricing

## Standard-Series Ring Lights

Features:

- No driver/controller required
- HS (High Speed) Strobe

Technology

- 24 VDC
- M12 connector for quick disconnect
- Available in 2 colors, Ultra-Violet, and Infrared
- Available in 4 sizes
- 10 Year Warranty\* - 100,000 hours

### Ring Lights

<u>Standard-Series Ring Lights - No Driver Required</u>	<u>54-55</u>
<u>Monster-Series Ring Lights - External Driver Included</u>	<u>56-59</u>
<u>Monster-Series Ring Lights - With Internal Driver</u>	<u>60</u>

This page is intentionally blank

### Standard-Series Ring Lights

- Features:
- No driver/controller required
  - HS (High Speed) Strobe Technology
  - 24 VDC
  - M12 connector for quick disconnect
  - Available in 2 colors, Ultra-Violet, and Infrared
  - Available in 4 sizes
  - 10 Year Warranty\* - 100,000 hours

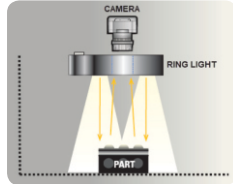

To Order, Specify;	
1 Base Part Number	<b>RL4</b>
Example:	<b>\$675</b>
2 Specify LED Color	<b>660</b>
	<b>+ \$0</b>
3 Specify Diffuser Type	<b>SD</b>
	<b>+ \$0</b>
4 Specify Cable Option	<b>SC4</b>
	<b>+ \$0</b>

1 Base Part Number	List Price	2 LED Color	3 Diffuser Type	4 Cable Option
<b>RL4</b>	<b>\$675</b>	<b>660 + \$0</b> Red	<b>SD + \$0</b> Standard Diffuser	<b>SC4 + \$0</b> Standard Cable 4 meter
4" Ring Light LED - Package Includes Light, and 4 Meter Cable		<b>880 + \$0</b> Infrared	<b>CC + \$0</b> Clear Cover	<b>SC8 + \$50</b> Standard Cable 8 meter
		<b>WHI + \$0</b> White	<b>TFD + \$25</b> Thin Film Diffuser	<b>SC15 + \$85</b> Standard Cable 15 meter
			<b>WD + \$0</b> White Diffuser	<b>SC30 *</b> Standard Cable 30 meter
			<b>P + \$25</b> Polarizer	<b>SCHF4 + \$35</b> Standard High Flex Cable 4 meter
				<b>SCHF8 + \$60</b> Standard High Flex Cable 8 meter
				<b>SCHF15 + \$160</b> Standard High Flex Cable 15 meter

Dimensions: D 4.75" CC 14.915" H 1.125" Wgt .7 lbs (\*) Call for pricing

1 Base Part Number	List Price	2 LED Color	3 Diffuser Type	4 Cable Option
<b>RL70</b>	<b>\$275</b>	<b>W-WHI + \$0</b> Wide Angle White	No Options	No Options
Pelco Ring Lights Board with Wide or Medium Angle Lenses		<b>W-470 + \$0</b> Wide Angle Blue		
		<b>W-630 + \$0</b> Wide Angle Red		
		<b>M-630 + \$0</b> Medium Angle Red		
		<b>M-880 + \$0</b> Medium Angle Infrared		
		<b>W-880 + \$0</b> Wide Angle Infrared		

Dimensions: W 2.7" L 3.015" H " Wgt lbs (\*) Call for pricing

### Standard-Series Ring Lights

- Features:
- No driver/controller required
  - HS (High Speed) Strobe Technology
  - 24 VDC
  - M12 connector for quick disconnect
  - Available in 2-3 colors, Ultra-Violet, and Infrared
  - Available in 4 sizes
  - 10 Year Warranty\* - 100,000 hours

To Order, Specify;	
1 Base Part Number	<b>RL/DF4</b>
Example:	<b>\$2000</b>
2 Specify LED Color	<b>880</b>
	<b>+ \$0</b>
3 Specify Diffuser Type	<b>SD</b>
	<b>+ \$0</b>
4 Specify Cable Option	<b>SC4</b>
	<b>+ \$0</b>

1 Base Part Number	List Price	2 LED Color	3 Diffuser Type	4 Cable Option
<b>RL/DF4</b>	<b>\$2000</b>	<b>880 + \$0</b> Infrared	<b>SD + \$0</b> Standard Diffuser	<b>SC4 + \$0</b> Standard Cable 4 meter
4" X 4" Ring Light Adjustable Dark Field - Package Includes Light, and 4 Meter Cable		<b>630 + \$0</b> Red	<b>TFD + \$75</b> Thin Film Diffuser	<b>SC8 + \$50</b> Standard Cable 8 meter
			<b>WD + \$0</b> White Diffuser	<b>SC15 + \$85</b> Standard Cable 15 meter
			<b>P + \$75</b> Polarizer	<b>SC30 *</b> Standard Cable 30 meter
				<b>SCHF4 + \$35</b> Standard High Flex Cable 4 meter
				<b>SCHF8 + \$60</b> Standard High Flex Cable 8 meter
				<b>SCHF15 + \$160</b> Standard High Flex Cable 15 meter

Dimensions: W 10" L 10" H 1.875" Wgt 5.85 lbs (\*) Call for pricing

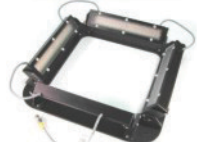
1 Base Part Number	List Price	2 LED Color	3 Diffuser Type	4 Cable Option
<b>RL/DF8</b>	<b>\$3250</b>	<b>880 + \$0</b> Infrared	<b>SD + \$0</b> Standard Diffuser	<b>SC4 + \$0</b> Standard Cable 4 meter
8" X 8" Ring Light Adjustable Dark Field - Package Includes Light, and 4 Meter Cable		<b>630 + \$0</b> Red	<b>TFD + \$125</b> Thin Film Diffuser	<b>SC8 + \$50</b> Standard Cable 8 meter
			<b>WD + \$0</b> White Diffuser	<b>SC15 + \$85</b> Standard Cable 15 meter
			<b>P + \$125</b> Polarizer	<b>SC30 *</b> Standard Cable 30 meter
				<b>SCHF4 + \$35</b> Standard High Flex Cable 4 meter
				<b>SCHF8 + \$60</b> Standard High Flex Cable 8 meter
				<b>SCHF15 + \$160</b> Standard High Flex Cable 15 meter

Dimensions: W 14" L 14" H 1.875" Wgt lbs (\*) Call for pricing

## Monster-Series Ring Lights

### Features:

- External driver/controller included
- HS (High Speed) Strobe Technology
- High Power LED's (24 VDC)
- M12 connector for quick disconnect
- Available in 8 colors, Ultra-Violet, and Infrared
- Available in 7 sizes
- 10 Year Warranty\* - 100,000 hours

### Caution –

The supplied LDM adapter must be used for both continuous or strobe operations! Do not connect the fixture directly to 24VDC! Operating the fixture without the supplied LDM adapter will result in premature LED failure and will void the warranty.



### To Order, Specify;

1 Base Part Number	2 LED Color	3 Lens	4 Diffuser	5 Driver Option	6 Cable Option
3.5" Ring Light LED's - Pack-					
<b>MRL2.5</b>	<b>470</b>	<b>16</b>	<b>SD</b>	<b>A</b>	<b>MC4</b>
<b>\$650</b>	<b>\$0</b>	<b>\$0</b>	<b>\$0</b>	<b>\$85</b>	<b>\$0</b>

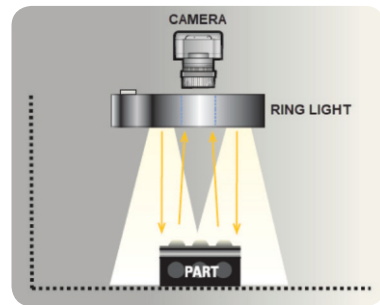

Bright Field Ring Lights provide illumination directly onto an object, at angles of incidence above 45 degrees from horizontal, creating distinct shadows or general purpose illumination depending on subject features. This type of lighting is effective when used on objects requiring high degrees of contrast, but may create unwanted specular reflections when directed at shiny or reflective materials because of the high angle of incidence. Working distances can be short to very long.

### Application Examples

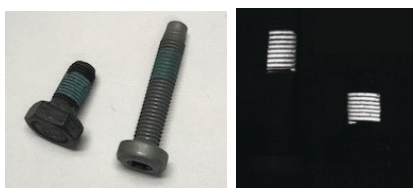

Object: Bolt coating Inspection. Bolts with resin applied for thread lock. UV light illuminated the resin coating.

## Monster-Series Ring Lights

1 Base Part Number	List Price	2 LED	3 Lens	4 Diffuser	5 Driver	6 Cable
<b>MRL2.5</b>	<b>\$650</b>	<b>365 + \$100</b> Ultraviolet 365nm	<b>16 + \$0</b> 16 Degree	<b>SD + \$0</b> Standard	<b>LDM350/2 + \$0</b> 350mA Driver	<b>MC4 + \$0</b> 4 meter
2.5" Ring Light LED - Package Includes Light, LDM 350/2, and 4 Meter Cable		<b>470 + \$0</b> Blue	<b>60 + \$0</b> 60 Degree	<b>CC + \$0</b> Clear Cover	<b>A + \$85</b> ALDM Driver	<b>MC8 + \$20</b> 8 meter
		<b>530 + \$0</b> Green	<b>R60 + \$0</b> Reflector 60 & UV	<b>TFD + \$25</b> Thin Film	<b>V + \$85</b> VLDM Driver	<b>MC15 + \$60</b> 15 meter
		<b>630 + \$0</b> Red		<b>WD + \$0</b> White	<b>RV + \$100</b> RVLDM Driver	<b>MC30 *</b> 30 meter
		<b>850 + \$100</b> Infrared		<b>P + \$25</b> Polarizer		<b>MCHF4 + \$35</b> High Flex 4 meter
		<b>WHI + \$0</b> White		<b>UVCC + \$0</b> UV Clear Cover		<b>MCHF8 + \$60</b> High Flex 8 meter
						<b>MCHF15 *</b> High Flex 15 meter
						<b>MCHF30 *</b> High Flex 30 meter



Dimensions: W 2.375" L 2.375" H .75" Wgt .35 lbs

(\*) Call for pricing

<b>MRL3.5</b>	<b>\$800</b>	<b>365 + \$100</b> UV 365nm	<b>12 + \$0</b> 12 Degree	<b>SD + \$0</b> Standard	<b>LDM700 + \$0</b> 700mA Driver	<b>MC4 + \$0</b> 4 meter
3.5" Ring Light LED's - Package Includes Light, LDM 700, and 4 Meter Cable		<b>395 + \$100</b> UV 395nm	<b>16 + \$0</b> 16 Frosted	<b>CC + \$0</b> Clear Cover	<b>A + \$85</b> ALDM Driver	<b>MC8 + \$20</b> 8 meter
		<b>470 + \$0</b> Blue	<b>23 + \$0</b> 23 Frosted	<b>TFD + \$25</b> Thin Film	<b>V + \$85</b> VLDM Driver	<b>MC15 + \$60</b> 15 meter
		<b>530 + \$0</b> Green	<b>30 + \$0</b> 30 Frosted	<b>WD + \$0</b> White	<b>RV + \$100</b> RVLDM Driver	<b>MC30 *</b> 30 meter
		<b>630 + \$0</b> Red	<b>39 + \$0</b> 39 Frosted	<b>P + \$25</b> Polarizer		<b>MCHF4 + \$35</b> High Flex 4 meter
		<b>850 + \$100</b> Infrared	<b>50 + \$0</b> 50 Degree	<b>UVCC + \$0</b> UV Clear Cover		<b>MCHF8 + \$60</b> High Flex 8 meter
		<b>WHI + \$0</b> White	<b>F + \$0</b> Wide Angle			<b>MCHF15 *</b> High Flex 15 meter
		<b>NWH + \$0</b> Neutral White	<b>R + \$0</b> Reflector 90			<b>MCHF30 *</b> High Flex 30 meter
			<b>L + \$0</b> Line			



Dimensions: W 4.375" CC 13.738" H 1.125" Wgt .85 lbs

(\*) Call for pricing

<b>MRL5.5</b>	<b>\$1000</b>	<b>365 + \$150</b> UV 365nm	<b>12 + \$0</b> 12 Degree	<b>SD + \$0</b> Standard	<b>LDM700 + \$0</b> 700mA Driver	<b>MC4 + \$0</b> 4 meter
5.5" Ring Light LED - Package Includes Light, LDM 700, and 4 Meter Cable		<b>395 + \$150</b> UV 395nm	<b>16 + \$0</b> 16 Frosted	<b>CC + \$0</b> Clear Cover	<b>A + \$85</b> ALDM Driver	<b>MC8 + \$20</b> 8 meter
		<b>470 + \$0</b> Blue	<b>23 + \$0</b> 23 Frosted	<b>TFD + \$25</b> Thin Film	<b>V + \$85</b> VLDM Driver	<b>MC15 + \$60</b> 15 meter
		<b>530 + \$0</b> Green	<b>30 + \$0</b> 30 Frosted	<b>WD + \$0</b> White	<b>RV + \$100</b> RVLDM Driver	<b>MC30 *</b> 30 meter
		<b>630 + \$0</b> Red	<b>39 + \$0</b> 39 Frosted	<b>P + \$35</b> Polarizer		<b>MCHF4 + \$35</b> High Flex 4 meter
		<b>850 + \$150</b> Infrared	<b>50 + \$0</b> 50 Degree	<b>UVCC + \$0</b> UV Clear Cover		<b>MCHF8 + \$60</b> High Flex 8 meter
		<b>940 + \$200</b> Infrared	<b>F + \$0</b> Wide Angle			<b>MCHF15 *</b> High Flex 15 meter
		<b>WHI + \$0</b> White	<b>R + \$0</b> Reflector 90			<b>MCHF30 *</b> High Flex 30 meter
		<b>NWH + \$0</b> Neutral White	<b>L + \$0</b> Line			



Dimensions: D 6.75" CC 21.195" H 1.125" Wgt 1.5 lbs

(\*) Call for pricing

### Monster-Series Ring Lights

1 Base Part Number	List Price	2 LED	3 Lens	4 Diffuser	5 Driver	6 Cable
<b>MRL5.5-XXX-YYY</b> 5.5" Ring Light, 2 Channels/ colors of LED, 2 LDM 700s, and 4 Meter Cable	<i>Call for Pricing</i>	<b>365 +</b> UV 365nm <b>395 +</b> UV 395nm <b>470 +</b> Blue <b>530 +</b> Green <b>630 +</b> Red <b>850 +</b> Infrared <b>WHI +</b> White <b>NWH +</b> Neutral White	<b>12 + \$0</b> 12 Degree <b>16 + \$0</b> 16 Frosted <b>23 + \$0</b> 23 Frosted <b>30 + \$0</b> 30 Frosted <b>39 + \$0</b> 39 Frosted <b>50 + \$0</b> 50 Degree <b>F + \$0</b> Wide Angle <b>R + \$0</b> Reflector 90 <b>L + \$0</b> Line	<b>SD + \$0</b> Standard <b>CC + \$0</b> Clear Cover <b>TFD + \$25</b> Thin Film <b>WD + \$0</b> White <b>P + \$25</b> Polarizer <b>UVCC + \$0</b> UV Clear Cover	<b>LDM700 + \$0</b> 700mA Driver <b>A + \$170</b> ALDM Driver <b>V + \$170</b> VLDM Driver <b>RV + \$200</b> RVLDM Driver	<b>MC4 + \$0</b> 4 meter <b>MC8 + \$20</b> 8 meter <b>MC15 + \$60</b> 15 meter <b>MC30 *</b> 30 meter <b>MCHF4 + \$35</b> High Flex 4 meter <b>MCHF8 + \$60</b> High Flex 8 meter <b>MCHF15 *</b> High Flex 15 meter <b>MCHF30 *</b> High Flex 30 meter

Dimensions: D 6.75" CC 21.195" H 1.125" Wgt 1.5 lbs

(\*) Call for pricing

<b>MRL8.5</b> 8.5" Ring Light LED - Pack- age Includes Light, LDM 700, and 4 Meter Cable	<b>\$1700</b>	<b>365 + \$150</b> UV 365nm <b>395 + \$150</b> UV 395nm <b>470 + \$0</b> Blue <b>530 + \$0</b> Green <b>630 + \$0</b> Red <b>850 + \$150</b> Infrared <b>WHI + \$0</b> White <b>NWH + \$0</b> Neutral White	<b>12 + \$0</b> 12 Degree <b>16 + \$0</b> 16 Frosted <b>23 + \$0</b> 23 Frosted <b>30 + \$0</b> 30 Frosted <b>39 + \$0</b> 39 Frosted <b>50 + \$0</b> 50 Degree <b>F + \$0</b> Wide Angle <b>R + \$0</b> Reflector 90 <b>L + \$0</b> Line	<b>SD + \$0</b> Standard <b>CC + \$0</b> Clear Cover <b>TFD + \$50</b> Thin Film <b>WD + \$0</b> White <b>UVCC + \$0</b> UV Clear Cover	<b>LDM700 + \$0</b> 700mA Driver <b>A + \$85</b> ALDM Driver <b>V + \$85</b> VLDM Driver <b>RV + \$100</b> RVLDM Driver	<b>MC4 + \$0</b> 4 meter <b>MC8 + \$20</b> 8 meter <b>MC15 + \$60</b> 15 meter <b>MC30 *</b> 30 meter <b>MCHF4 + \$35</b> High Flex 4 meter <b>MCHF8 + \$60</b> High Flex 8 meter <b>MCHF15 *</b> High Flex 15 meter <b>MCHF30 *</b> High Flex 30 meter
---	---------------	--	--	--	--	--

Dimensions: D 12" CC 37.68" H 1.25" Wgt 4.71 lbs

(\*) Call for pricing

<b>MRL13.5</b> 13.5" Ring Light LED - Pack- age Includes Light, LDM 1400, and 4 Meter Cable	<b>\$2250</b>	<b>365 + \$300</b> UV 365nm <b>395 + \$300</b> UV 395nm <b>470 + \$0</b> Blue <b>530 + \$0</b> Green <b>630 + \$0</b> Red <b>850 + \$300</b> Infrared <b>WHI + \$0</b> White <b>NWH + \$0</b> Neutral White	<b>12 + \$0</b> 12 Degree <b>16 + \$0</b> 16 Frosted <b>23 + \$0</b> 23 Frosted <b>30 + \$0</b> 30 Frosted <b>39 + \$0</b> 39 Frosted <b>50 + \$0</b> 50 Degree <b>F + \$0</b> Wide Angle <b>R + \$0</b> Reflector 90 <b>L + \$0</b> Line	<b>SD + \$0</b> Standard <b>CC + \$0</b> Clear Cover <b>TFD + \$75</b> Thin Film <b>WD + \$0</b> White <b>UVCC + \$0</b> UV Clear Cover	<b>LDM1400 + \$0</b> 1400mA Driver <b>A + \$85</b> ALDM Driver <b>V + \$85</b> VLDM Driver <b>RV + \$100</b> RVLDM Driver	<b>MC4 + \$0</b> 4 meter <b>MC8 + \$20</b> 8 meter <b>MC15 + \$60</b> 15 meter <b>MC30 *</b> 30 meter <b>MCHF4 + \$35</b> High Flex 4 meter <b>MCHF8 + \$60</b> High Flex 8 meter <b>MCHF15 *</b> High Flex 15 meter <b>MCHF30 *</b> High Flex 30 meter
--	---------------	--	--	--	--	--

Dimensions: D 16.875" CC 52.987" H 1.25" Wgt lbs

(\*) Call for pricing

### Monster-Series Ring Lights

1 Base Part Number	List Price	2 LED	3 Lens	4 Diffuser	5 Driver	6 Cable
<b>MRL19.5</b> 19.5" Ring Light LED- Pack- age Includes Light, LDM 2100, and 4 Meter Cable	<b>\$3250</b>	<b>365 + \$450</b> UV 365nm <b>395 + \$450</b> UV 395nm <b>470 + \$0</b> Blue <b>530 + \$0</b> Green <b>630 + \$0</b> Red <b>850 + \$450</b> Infrared <b>WHI + \$0</b> White <b>NWH + \$0</b> Neutral White	<b>12 + \$0</b> 12 Degree <b>16 + \$0</b> 16 Frosted <b>23 + \$0</b> 23 Frosted <b>30 + \$0</b> 30 Frosted <b>39 + \$0</b> 39 Frosted <b>50 + \$0</b> 50 Degree <b>F + \$0</b> Wide Angle <b>R + \$0</b> Reflector 90 <b>L + \$0</b> Line	<b>SD + \$0</b> Standard <b>CC + \$0</b> Clear Cover <b>TFD + \$100</b> Thin Film <b>WD + \$0</b> White <b>UVCC + \$0</b> UV Clear Cover	<b>LDM2100 + \$0</b> 2100mA Driver <b>A + \$85</b> ALDM Driver <b>V + \$85</b> VLDM Driver <b>RV + \$100</b> RVLDM Driver	<b>MC4 + \$0</b> 4 meter <b>MC8 + \$20</b> 8 meter <b>MC15 + \$60</b> 15 meter <b>MC30 *</b> 30 meter <b>MCHF4 + \$35</b> High Flex 4 meter <b>MCHF8 + \$60</b> High Flex 8 meter <b>MCHF15 *</b> High Flex 15 meter <b>MCHF30 *</b> High Flex 30 meter

Dimensions: D 23.125" CC 72.612" H 1.25" Wgt lbs

(\*) Call for pricing

<b>MRL30.5</b> 30.5" Ring Light LED - Pack- age Includes Light, LDM 2800 and 4 Meter Cable	<b>\$4500</b>	<b>365 + \$300</b> UV 365nm <b>395 + \$300</b> UV 395nm <b>470 + \$0</b> Blue <b>530 + \$0</b> Green <b>630 + \$0</b> Red <b>850 + \$300</b> Infrared <b>WHI + \$0</b> White <b>NWH + \$0</b> Neutral White	<b>12 + \$0</b> 12 Degree <b>16 + \$0</b> 16 Frosted <b>23 + \$0</b> 23 Frosted <b>30 + \$0</b> 30 Frosted <b>39 + \$0</b> 39 Frosted <b>50 + \$0</b> 50 Degree <b>F + \$0</b> Wide Angle <b>R + \$0</b> Reflector 90 <b>L + \$0</b> Line	<b>SD + \$0</b> Standard <b>CC + \$0</b> Clear Cover <b>TFD + \$250</b> Thin Film <b>WD + \$0</b> White <b>UVCC + \$0</b> UV Clear Cover	<b>LDM2800 + \$0</b> 2800mA Driver <b>A + \$85</b> ALDM Driver <b>V + \$85</b> VLDM Driver <b>RV + \$100</b> RVLDM Driver	<b>MC4 + \$0</b> 4 meter <b>MC8 + \$20</b> 8 meter <b>MC15 + \$60</b> 15 meter <b>MC30 *</b> 30 meter <b>MCHF4 + \$35</b> High Flex 4 meter <b>MCHF8 + \$60</b> High Flex 8 meter <b>MCHF15 *</b> High Flex 15 meter <b>MCHF30 *</b> High Flex 30 meter
---	---------------	--	--	---	--	--

Dimensions: D 34" CC 106.76" H 1.25" Wgt lbs

(\*) Call for pricing

### Monster-Series Ring Lights with Internal Driver

Features:

- Internal Driver - Plug & Play
- Auto Burst Technology
- High Power LED's (24 VDC)
- M12 connector for quick disconnect
- Available in 8 colors, Ultra-Violet, and Infrared
- Available in 2 sizes
- 0 - 10 VDC intensity Control
- Potentiometer Intensity Control
- 10 Year Warranty\* - 100,000 hours

To Order, Specify;				
1 Base Part Number	2 LED Color	3 Lens Type	4 Diffuser	5 Cable Option
<b>MRLD5.5</b>	<b>470</b>	<b>16</b>	<b>CC</b>	<b>EC5</b>
<b>\$1050</b>	<b>\$0</b>	<b>\$0</b>	<b>\$0</b>	<b>\$20</b>

1 Base Part Number	List Price	2 LED	3 LensType	4 Diffuser	5 Cable
<b>MRLD3.5</b> 3.5" Ring Light LED - Package Includes Light and 3 Meter Cable  	<b>\$850</b>	<b>365 + \$100</b> Ultraviolet 365nm	<b>12 + \$0</b> 12 Degree	<b>SD + \$0</b> Standard Diffuser	<b>EC3 + \$0</b> 3 Meter
		<b>395 + \$100</b> Ultraviolet 395nm	<b>16 + \$0</b> 16 Frosted	<b>CC + \$0</b> Clear Cover	<b>EC5 + \$20</b> 5 Meter
		<b>470 + \$0</b> Blue	<b>23 + \$0</b> 23 Frosted	<b>TFD + \$25</b> Thin Film Diffuser	
		<b>530 + \$0</b> Green	<b>30 + \$0</b> 30 Frosted	<b>WD + \$0</b> White Diffuser	
		<b>630 + \$0</b> Red	<b>39 + \$0</b> 39 Frosted	<b>P + \$25</b> Polarizer	
		<b>850 + \$100</b> Infrared	<b>50 + \$0</b> 50 Degree	<b>UVCC + \$0</b> UV Clear Cover	
		<b>WHI + \$0</b> White	<b>F + \$0</b> Wide Angle		
		<b>NWH + \$0</b> Neutral White	<b>R + \$0</b> Reflector 90		
			<b>L + \$0</b> Line		
		Dimensions: D 4.375" CC 13.783" H 1.25" Wgt .85 lbs			

<b>MRLD5.5</b> 5.5" Ring Light LED's - Package Includes Light and 3 Meter Cable  	<b>\$1050</b>	<b>365 + \$150</b> Ultraviolet 365nm	<b>12 + \$0</b> 12 Degree	<b>SD + \$0</b> Standard Diffuser	<b>EC3 + \$0</b> 3 Meter
		<b>395 + \$150</b> Ultraviolet 395nm	<b>16 + \$0</b> 16 Frosted	<b>CC + \$0</b> Clear Cover	<b>EC5 + \$20</b> 5 Meter
		<b>470 + \$0</b> Blue	<b>23 + \$0</b> 23 Frosted	<b>TFD + \$25</b> Thin Film Diffuser	
		<b>530 + \$0</b> Green	<b>30 + \$0</b> 30 Frosted	<b>WD + \$0</b> White Diffuser	
		<b>630 + \$0</b> Red	<b>39 + \$0</b> 39 Frosted	<b>P + \$35</b> Polarizer	
		<b>850 + \$150</b> Infrared	<b>50 + \$0</b> 50 Degree	<b>UVCC + \$0</b> UV Clear Cover	
		<b>WHI + \$0</b> White	<b>F + \$0</b> Wide Angle		
		<b>NWH + \$0</b> Neutral White	<b>R + \$0</b> Reflector 90		
			<b>L + \$0</b> Line		
		Dimensions: D 4.375" CC 13.783" H 1.25" Wgt .85 lbs			

This page is intentionally blank

Back Lights  
Diffused Axial  
Dome Lights  
Linear Lights  
Oxy Lights  
Ring Lights  
Spot Lights  
Washdown Lights  
Controllers & Cables

Back Lights  
Diffused Axial  
Dome Lights  
Linear Lights  
Oxy Lights  
Ring Lights  
Spot Lights  
Washdown Lights  
Controllers & Cables

### Spot Lights

E-Series Spot Lights - Internal Driver	63
Monster-Series Spot Lights - External Driver	64-65
Monster-Series Xtreme Spot Lights - Internal Driver	66

### E-Series Spot Lights

- Features:
- Internal driver/controller included
  - Auto Burst 3.5x Technology
  - Thermal Protection to reduce downtime
  - High Power LED's (24 VDC)
  - Internal driver/controller
  - M12 connector for quick disconnect
  - Available in 5 colors, Ultra-Violet, and Infrared
  - Available in 1 size and 40mm Spot Light
  - 10 Year Warranty\* - 50,000 hours

To Order, Specify;

① Base Part Number	② LED Color	③ Lens Type	④ Diffuser	⑤ Cable Option
<b>ES40</b>	<b>470</b>	<b>16</b>	<b>CC</b>	<b>EC3</b>
<b>\$425</b>	<b>\$0</b>	<b>\$0</b>	<b>\$0</b>	<b>\$0</b>

① Base Part Number	List Price	② LED	③ LensType	④ Diffuser	⑤ Cable
<b>ES40</b> E-Series 40mm Spot Light With LED and 3 Meter Cable 	<b>\$425</b>	<b>365 + \$50</b> Ultraviolet 365nm	<b>16 + \$0</b> 16 Frosted	<b>SD + \$0</b> Standard Diffuser	<b>EC3 + \$0</b> 3 Meter
		<b>395 + \$50</b> Ultraviolet 395nm	<b>23 + \$0</b> 23 Frosted	<b>CC + \$0</b> Clear Cover	<b>EC5 + \$20</b> 5 Meter
		<b>470 + \$0</b> Blue	<b>39 + \$0</b> 39 Frosted	<b>TFD + \$15</b> Thin Film Diffuser	
		<b>530 + \$0</b> Green	<b>R + \$0</b> Reflector 90	<b>WD + \$0</b> White Diffuser	
		<b>630 + \$0</b> Red	<b>L + \$0</b> Line	<b>P + \$25</b> Polarizer	
		<b>850 + \$50</b> Infrared		<b>UVCC + \$0</b> UV Clear Cover	
		<b>WHI + \$0</b> White			

Dimensions: W 1.506" L 3.301" H 1.181" Wgt .5 lbs

(\* Call for pricing)

## Monster-Series Spot Lights

### Features:

- External driver/controller included
- HS (High Speed) Strobe Technology
- High Power LED's (24 VDC)
- DIN rail mount driver/controller
- M12 connector for quick disconnect
- Available in 8 colors, Ultra-Violet, and Infrared
- Available in 3 sizes
- 10 Year Warranty\* - 100,000 hours



### Caution –

The supplied LDM adapter must be used for both continuous or strobe operations! Do not connect the fixture directly to 24VDC! Operating the fixture without the supplied LDM adapter will result in premature LED failure and will void the warranty.

### To Order, Specify;

1 Base Part Number	2 LED Color	3 Lens	4 Diffusser	5 Driver Option	6 Cable Option
3.5" Ring Light LED's - Pack-					
<b>MRL2.5</b>	<b>470</b>	<b>16</b>	<b>SD</b>	<b>A</b>	<b>MC4</b>
<b>\$650</b>	<b>\$0</b>	<b>\$0</b>	<b>\$0</b>	<b>\$85</b>	<b>\$0</b>

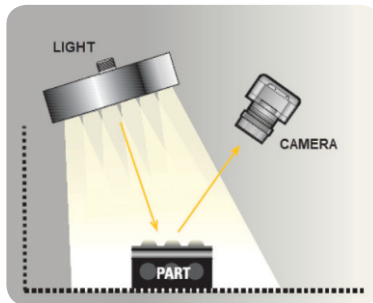

Spot Lights are typically characterized as general purpose lighting. They may be used to create both bright field and dark field effects, depending on the light angle of incidence. Working distances can be short to long, depending on available intensity and beam spread. Small spot lights are beneficial when deployed in tight spaces.

### Application Examples



Object: Optical Inspection of PCB board  
Machine reads the component's datamatrix serial number and checks the part's body for surface defects.

1 Base Part Number	List Price	2 LED	3 Lens	4 Diffuser	5 Driver	6 Cable
--------------------	------------	-------	--------	------------	----------	---------

<b>MSP1.25</b>	<b>\$500</b>	<b>365 + \$50</b> UV 365nm	<b>12 + \$0</b> 12 Degree	<b>SD + \$0</b> Standard	<b>LDM350/1+ \$0</b> 350mA Driver	<b>MC4 + \$0</b> 4 meter
1.25" Spot Light LED - Package Includes Light, LDM 350/1, and 4 Meter Cable		<b>395 + \$50</b> UV 395nm	<b>16 + \$0</b> 16 Frosted	<b>CC + \$0</b> Clear Cover	<b>A + \$85</b> ALDM Driver	<b>MC8 + \$20</b> 8 meter
		<b>470 + \$0</b> Blue	<b>23 + \$0</b> 23 Frosted	<b>TFD + \$25</b> Thin Film	<b>V + \$85</b> VLDM Driver	<b>MC15 + \$60</b> 15 meter
		<b>530 + \$0</b> Green	<b>30 + \$0</b> 30 Frosted	<b>WD + \$0</b> White	<b>RV + \$100</b> RVLDM Driver	<b>MC30 *</b> 30 meter
		<b>630 + \$0</b> Red	<b>39 + \$0</b> 39 Frosted	<b>P + \$25</b> Polarizer		<b>MCHF4 + \$35</b> High Flex 4 meter
		<b>850 + \$50</b> Infrared	<b>50 + \$0</b> 50 Degree	<b>UVCC + \$0</b> UV Clear Cover		<b>MCHF8 + \$60</b> High Flex 8 meter
		<b>WHI + \$0</b> White	<b>F + \$0</b> Wide Angle			<b>MCHF15 *</b> High Flex 15 meter
		<b>NWH + \$0</b> Neutral White	<b>R + \$0</b> Reflector 90			<b>MCHF30 *</b> High Flex 30 meter
			<b>L + \$0</b> Line			

Dimensions: W 3.062" L 2.781" H 1.125" Wgt .32 lbs

(\* Call for pricing)

<b>MSP3.25</b>	<b>\$700</b>	<b>365 + \$100</b> UV 365nm	<b>12 + \$0</b> 12 Degree	<b>SD + \$0</b> Standard	<b>LDM350/3+ \$0</b> 350mA Driver	<b>MC4 + \$0</b> 4 meter
3.25" Spot Light LED's - Package Includes Light, LDM 350/3 (LDM 350/2 For Ir), and 4 Meter Cable		<b>395 + \$100</b> UV 395nm	<b>16 + \$0</b> 16 Frosted	<b>CC + \$0</b> Clear Cover	<b>A + \$85</b> ALDM Driver	<b>MC8 + \$20</b> 8 meter
		<b>470 + \$0</b> Blue	<b>23 + \$0</b> 23 Frosted	<b>TFD + \$25</b> Thin Film	<b>V + \$85</b> VLDM Driver	<b>MC15 + \$60</b> 15 meter
		<b>530 + \$0</b> Green	<b>30 + \$0</b> 30 Frosted	<b>WD + \$0</b> White	<b>RV + \$100</b> RVLDM Driver	<b>MC30 *</b> 30 meter
		<b>630 + \$0</b> Red	<b>39 + \$0</b> 39 Frosted	<b>P + \$25</b> Polarizer		<b>MCHF4 + \$35</b> High Flex 4 meter
		<b>850 + \$100</b> Infrared	<b>50 + \$0</b> 50 Degree	<b>UVCC + \$0</b> UV Clear Cover		<b>MCHF8 + \$60</b> High Flex 8 meter
		<b>WHI + \$0</b> White	<b>F + \$0</b> Wide Angle			<b>MCHF15 *</b> High Flex 15 meter
		<b>NWH + \$0</b> Neutral White	<b>R + \$0</b> Reflector 90			<b>MCHF30 *</b> High Flex 30 meter
			<b>L + \$0</b> Line			

Dimensions: D 4.25" CC 13.345" H 1.125" Wgt .7 lbs

(\* Call for pricing)

<b>MSP5.5</b>	<b>\$1400</b>	<b>365 + \$150</b> UV 365nm	<b>12 + \$0</b> 12 Degree	<b>SD + \$0</b> Standard	<b>LDM350/3+ \$0</b> 350mA Driver	<b>MC4 + \$0</b> 4 meter
5.5" Spot Light LED's - Package Includes Light, LDM 1050, and 4 Meter Cable		<b>395 + \$150</b> UV 395nm	<b>16 + \$0</b> 16 Frosted	<b>CC + \$0</b> Clear Cover	<b>A + \$85</b> ALDM Driver	<b>MC8 + \$20</b> 8 meter
		<b>470 + \$0</b> Blue	<b>23 + \$0</b> 23 Frosted	<b>TFD + \$25</b> Thin Film	<b>V + \$85</b> VLDM Driver	<b>MC15 + \$60</b> 15 meter
		<b>530 + \$0</b> Green	<b>30 + \$0</b> 30 Frosted	<b>WD + \$0</b> White	<b>RV + \$100</b> RVLDM Driver	<b>MC30 *</b> 30 meter
		<b>630 + \$0</b> Red	<b>39 + \$0</b> 39 Frosted	<b>P + \$35</b> Polarizer		<b>MCHF4 + \$35</b> High Flex 4 meter
		<b>850 + \$150</b> Infrared	<b>50 + \$0</b> 50 Degree	<b>UVCC + \$0</b> UV Clear Cover		<b>MCHF8 + \$60</b> High Flex 8 meter
		<b>WHI + \$0</b> White	<b>F + \$0</b> Wide Angle			<b>MCHF15 *</b> High Flex 15 meter
		<b>NWH + \$0</b> Neutral White	<b>R + \$0</b> Reflector 90			<b>MCHF30 *</b> High Flex 30 meter
			<b>L + \$0</b> Line			

Dimensions: D 6.75" CC 21.195" H 1.125" Wgt 1.62 lbs

(\* Call for pricing)

### Monster-Series Xtreme Spot Lights

Features:

- Internal driver/controller included
- Auto Burst 3.5x Technology
- Ultra-High Power LED's (24 VDC)
- Robot friendly weight
- M12 connector for quick disconnect
- PNP and NPN inputs
- Thermal Protection
- Available in 2 colors and Infrared
- Available in 1 sizes
- 10 Year Warranty\* - 100,000 hours

To Order, Specify;	
1 Base Part Number	<b>XS40 \$450</b>
2 Specify LED Color	<b>WHI + \$0</b>
3 Specify Lens Type	<b>23 + \$0</b>
4 Specify Diffuser	<b>CC + \$0</b>
4 Specify Cable	<b>EC3 + \$0</b>

This page is intentionally blank

1 Base Part Number	List Price	2 LED	3 LensType	4 Diffuser	5 Cable
<b>XS40</b> Extreme Series 40mm Spot Light With LED and 3 Meter Cable	<b>\$450</b>	<b>WHI + \$0</b> White <b>NWH *</b> Neutral White	<b>23 + \$0</b> Optics 23 <b>32 + \$0</b> Optics 32 <b>56 + \$0</b> Optics 56	<b>CC + \$0</b> Clear Cover <b>SD + \$0</b> Standard Diffuser <b>TFD + \$15</b> Thin Film Diffuser <b>WD + \$0</b> White Diffuser <b>P + \$25</b> Polarizer	<b>EC3 + \$0</b> 3 Meter <b>EC5 + \$20</b> 5 Meter

Dimensions: W 1.506" L 3.301" H 1.181" Wgt .5 lbs (\*) Call for pricing

## Washdown Lights

Standard-Series Washdown Lights - No Driver Required	69-70
Monster-Series Washdown Lights - External Driver	71-73
Monster-Ring & Dome Washdown Lights - External Driver	74-75

## Standard-Series Washdown Lights

Features:

- No driver/controller required
- HS (High Speed) Strobe Technology
- 24 VDC
- M12 connector for quick disconnect
- IP68 and FDA Compliant
- Available in 4 colors and Infrared
- Available in 4 Back Light sizes and 1 Ring Light size
- 3 Year Warranty\* - 100,000 hours



### To Order, Specify;

1 Base Part Number	<b>WBL44</b>
Example:	<b>\$1750</b>
2 Specify LED Color	<b>470 + \$100</b>
3 Specify Diffuser Type	<b>WD + \$0</b>
4 Specify Cable Option	<b>WSC4 + \$0</b>

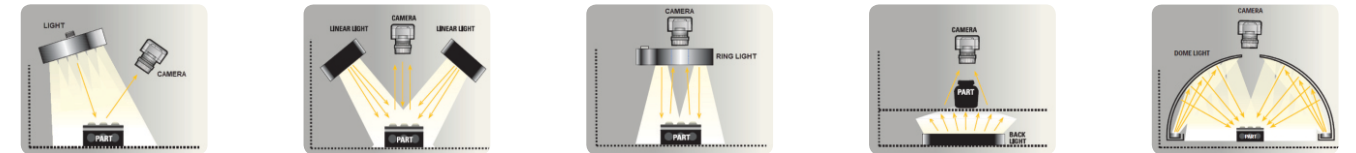

Object: Plastic Food Packaging  
Wash down dome light allows a clear image showing

1 Base Part Number	List Price	2 LED Color	3 Diffuser Type	4 Cable Option
<b>WBL44</b>	<b>\$1750</b>	<b>470 + \$100</b> Blue	<b>WD + \$0</b> White Diffuser	<b>WSC4 + \$0</b> Washdown Std Series Cable 4 meter
4" X 4" Back Light LED Wash Down - Package Includes Light, and 4 Meter Stainless Steel Cable		<b>530 + \$100</b> Green	<b>CC + \$0</b> Clear Cover	<b>WSC8 + \$60</b> Washdown Std Series Cable 8 meter
		<b>660 + \$0</b> Red	<b>SD + \$0</b> Standard Diffuser	<b>WSC15 + \$80</b> Washdown Std Series Cable 15 meter
		<b>880 + \$0</b> Infrared		<b>WSC30 *</b> Washdown Std Series Cable 30 meter
		<b>WHI + \$0</b> White		



Dimensions: W 6.25" L 6.25" H 2.125" Wgt . lbs

(\* ) Call for pricing

### Standard-Series Washdown Lights

1 Base Part Number	List Price	2 LED Color	3 Diffuser Type	4 Cable Option
<b>WBL48</b> 4" X 8" Back Light LED Wash Down - Package Includes Light, and 4 Meter Stainless Steel Cable	<b>\$2500</b>	<b>470 + \$200</b> Blue <b>660 + \$0</b> Red <b>880 + \$0</b> Infrared <b>WHI + \$0</b> White	<b>WD + \$0</b> White Diffuser <b>CC + \$0</b> Clear Cover <b>SD + \$0</b> Standard Diffuser	<b>WSC4 + \$0</b> Washdown Std Series Cable 4 meter <b>WSC8 + \$60</b> Washdown Std Series Cable 8 meter <b>WSC15 + \$80</b> Washdown Std Series Cable 15 meter <b>WSC30 *</b> Washdown Std Series Cable 30 mete
*Call for pricing				
Dimensions: W 6.25" L 10.25" H 2.25" Wgt 5.55 lbs (*) Call for pricing				



<b>WBL812</b> 8" X 12" Back Light LED Wash Down - Package Includes Light, and 4 Meter Stainless Steel Cable	<b>\$4000</b>	<b>470 + \$700</b> Blue <b>660 + \$0</b> Red <b>880 + \$0</b> Infrared <b>WHI + \$0</b> White	<b>WD + \$0</b> White Diffuser <b>CC + \$0</b> Clear Cover <b>SD + \$0</b> Standard Diffuser	<b>WSC4 + \$0</b> Washdown Std Series Cable 4 meter <b>WSC8 + \$60</b> Washdown Std Series Cable 8 meter <b>WSC15 + \$80</b> Washdown Std Series Cable 15 meter <b>WSC30 *</b> Washdown Std Series Cable 30 meter
Dimensions: W 10.31" L 14.31" H 2.25" Wgt lbs (*) Call for pricing				



<b>WRL4</b> Wash Down 4" Ring Light LED - Package Includes Light and Stainless Steel 4 Meter Cord	<b>\$1100</b>	<b>660 + \$0</b> Red <b>880 + \$0</b> Infrared <b>WHI + \$0</b> White	<b>SD + \$0</b> Standard Diffuser <b>WD + \$0</b> White Diffuser <b>P + \$25</b> Polarizer	<b>WSC4 + \$0</b> Washdown Std Series Cable 4 meter <b>WSC8 + \$60</b> Washdown Std Series Cable 8 meter <b>WSC15 + \$80</b> Washdown Std Series Cable 15 meter <b>WSC30 *</b> Washdown Std Series Cable 30 meter
Dimensions: D 4.875" CC 15.308" H 1.312" Wgt 1.7 lbs (*) Call for pricing				

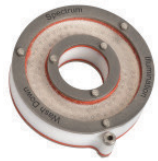

### Monster-Series Washdown Lights

Features:

- External driver/controller included
- HS (High Speed) Strobe Technology
- High Power LED's (24 VDC)
- DIN rail mount driver/controller
- M12 connector for quick disconnect
- IP68 and FDA Compliant
- Available in 7 colors, Ultra-Violet, and Infrared
- Available in 4 sizes and 2 Spot Lights
- 3 Year Warranty\* - 100,000 hours



Caution –

The supplied LDM adapter must be used for both continuous or strobe operations! Do not connect the fixture directly to 24VDC! Operating the fixture without the supplied LDM adapter will result in premature LED failure and will void the warranty.

To Order, Specify;					
1 Base Part Number	2 LED Color	3 Lens	4 Diffusser	5 Driver Option	6 Cable Option
3.5" Ring Light LED's - Pack-					
<b>WML111.5</b> <b>\$2000</b>	<b>470</b> <b>\$0</b>	<b>16</b> <b>\$0</b>	<b>SD</b> <b>\$0</b>	<b>A</b> <b>\$85</b>	<b>WMC4</b> <b>\$0</b>

1 Base Part Number	List Price	2 LED	3 Lens	4 Diffuser	5 Driver	6 Cable
<b>WMLL16</b> Wash Down 6" Linear Light LED - Package Includes Light, LDM 350/3, and 4 Meter Stainless Steel Cable	<b>\$1250</b>	<b>365 + \$50</b> UV 365nm <b>395 + \$50</b> UV 395nm <b>470 + \$0</b> Blue <b>530 + \$0</b> Green <b>630 + \$0</b> Red <b>850 + \$50</b> Infrared <b>WHI + \$0</b> White	<b>12 + \$0</b> 12 Degree <b>16 + \$0</b> 16 Frosted <b>23 + \$0</b> 23 Frosted <b>30 + \$0</b> 30 Frosted <b>39 + \$0</b> 39 Frosted <b>50 + \$0</b> 50 Degree <b>F + \$0</b> Wide Angle <b>R + \$0</b> Reflector 90 <b>L + \$0</b> Line	<b>SD + \$0</b> Standard <b>CC + \$0</b> Clear Cover <b>WD + \$0</b> White <b>UVCC + \$0</b> UV Clear Cover	<b>LDM350/3+ \$0</b> 350mA Driver <b>A + \$85</b> ALDM Driver <b>V + \$85</b> VLDM Driver <b>RV + \$100</b> RVLDM Driver	<b>WMC4 + \$0</b> 4 meter <b>WMC8 + \$55</b> 8 meter <b>WMC15 + \$75</b> 15 meter <b>WMC30 *</b> 30 meter
Dimensions: W 2.5" L 6.813" H 1.625" Wgt lbs (*) Call for pricing						



**Monster-Series Washdown Lights**

1 Base Part Number	List Price	2 LED	3 Lens	4 Diffuser	5 Driver	6 Cable
<b>WMLL111.5</b> Wash Down 11.5" Linear Light LED - Package Includes Light, LDM 700, and 4 Meter Stainless Steel Cable 	<b>\$2000</b>	<b>365 + \$100</b> UV 365nm <b>395 + \$100</b> UV 395nm <b>470 + \$0</b> Blue <b>530 + \$0</b> Green <b>630 + \$0</b> Red <b>850 + \$100</b> Infrared <b>WHI + \$0</b> White	<b>12 + \$0</b> 12 Degree <b>16 + \$0</b> 16 Frosted <b>23 + \$0</b> 23 Frosted <b>30 + \$0</b> 30 Frosted <b>39 + \$0</b> 39 Frosted <b>50 + \$0</b> 50 Degree <b>F + \$0</b> Wide Angle <b>R + \$0</b> Reflector 90 <b>L + \$0</b> Line	<b>SD + \$0</b> Standard <b>CC + \$0</b> Clear Cover <b>WD + \$0</b> White <b>UVCC + \$0</b> UV Clear Cover	<b>LDM700 + \$0</b> 700mA Driver <b>A + \$85</b> ALDM Driver <b>V + \$85</b> VLDM Driver <b>RV + \$100</b> RVLDM Driver	<b>WMC4 + \$0</b> 4 meter <b>WMC8 + \$55</b> 8 meter <b>WMC15 + \$75</b> 15 meter <b>WMC30 *</b> 30 meter
Dimensions: W 2.5" L 12.5" H 1.5" Wgt lbs				(*) Call for pricing		

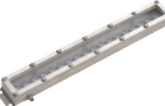
<b>WMLL117.25</b> Wash Down 17.25" Linear Light - Package Includes Light, LDM 1050 and 4 Meter Stainless Steel Cable 	<b>\$2250</b>	<b>365 + \$150</b> UV 365nm <b>395 + \$150</b> UV 395nm <b>470 + \$0</b> Blue <b>530 + \$0</b> Green <b>630 + \$0</b> Red <b>850 + \$150</b> Infrared <b>WHI + \$0</b> White	<b>12 + \$0</b> 12 Degree <b>16 + \$0</b> 16 Frosted <b>23 + \$0</b> 23 Frosted <b>30 + \$0</b> 30 Frosted <b>39 + \$0</b> 39 Frosted <b>50 + \$0</b> 50 Degree <b>F + \$0</b> Wide Angle <b>R + \$0</b> Reflector 90 <b>L + \$0</b> Line	<b>SD + \$0</b> Standard <b>CC + \$0</b> Clear Cover <b>WD + \$0</b> White <b>UVCC + \$0</b> UV Clear Cover	<b>LDM1050 + \$0</b> 1050mA Driver <b>A + \$85</b> ALDM Driver <b>V + \$85</b> VLDM Driver <b>RV + \$100</b> RVLDM Driver	<b>WMC4 + \$0</b> 4 meter <b>WMC8 + \$55</b> 8 meter <b>WMC15 + \$75</b> 15 meter <b>WMC30 *</b> 30 meter
Dimensions: W 2.5" L 18.25" H 1.56" Wgt lbs				(*) Call for pricing		

<b>WMLL123</b> Wash Down 23" Linear Light LED - Package Includes Light, LDM 1400, and 4 Meter Stainless Steel Cable 	<b>\$3000</b>	<b>365 + \$200</b> UV 365nm <b>395 + \$200</b> UV 395nm <b>470 + \$0</b> Blue <b>530 + \$0</b> Green <b>630 + \$0</b> Red <b>850 + \$200</b> Infrared <b>WHI + \$0</b> White	<b>12 + \$0</b> 12 Degree <b>16 + \$0</b> 16 Frosted <b>23 + \$0</b> 23 Frosted <b>30 + \$0</b> 30 Frosted <b>39 + \$0</b> 39 Frosted <b>50 + \$0</b> 50 Degree <b>F + \$0</b> Wide Angle <b>R + \$0</b> Reflector 90 <b>L + \$0</b> Line	<b>SD + \$0</b> Standard <b>CC + \$0</b> Clear Cover <b>WD + \$0</b> White <b>UVCC + \$0</b> UV Clear Cover	<b>LDM1400+ \$0</b> 1400mA Driver <b>A + \$85</b> ALDM Driver <b>V + \$85</b> VLDM Driver <b>RV + \$100</b> RVLDM Driver	<b>WMC4 + \$0</b> 4 meter <b>WMC8 + \$55</b> 8 meter <b>WMC15 + \$75</b> 15 meter <b>WMC30 *</b> 30 meter
Dimensions: W 2.5" L 24" H 1.625" Wgt 5.5 lbs				(*) Call for pricing		

**Monster-Series Washdown Lights**

1 Base Part Number	List Price	2 LED	3 Lens	4 Diffuser	5 Driver	6 Cable
<b>WMSP1.25</b> Wash Down 1.25" Spot Light LED - Package Includes Light, LDM 350/1, and 4 Meter Cable 	<b>\$650</b>	<b>365 + \$50</b> UV 365nm <b>395 + \$50</b> UV 395nm <b>470 + \$0</b> Blue <b>530 + \$0</b> Green <b>630 + \$0</b> Red <b>850 + \$50</b> Infrared <b>WHI + \$0</b> White	<b>12 + \$0</b> 12 Degree <b>16 + \$0</b> 16 Frosted <b>23 + \$0</b> 23 Frosted <b>30 + \$0</b> 30 Frosted <b>39 + \$0</b> 39 Frosted <b>50 + \$0</b> 50 Degree <b>F + \$0</b> Wide Angle <b>R + \$0</b> Reflector 90 <b>L + \$0</b> Line	<b>SD + \$0</b> Standard <b>CC + \$0</b> Clear Cover <b>WD + \$0</b> White <b>UVCC + \$0</b> UV Clear Cover	<b>LDM350/1+ \$0</b> 350mA Driver <b>A + \$85</b> ALDM Driver <b>V + \$85</b> VLDM Driver <b>RV + \$100</b> RVLDM Driver	<b>WMC4 + \$0</b> 4 meter <b>WMC8 + \$55</b> 8 meter <b>WMC15 + \$75</b> 15 meter <b>WMC30 *</b> 30 meter
Dimensions: W 2.5" L 3.219" H 1.438" Wgt .9 lbs				(*) Call for pricing		

<b>WMSP3.25</b> Wash Down 3.25" Spot Light LED - Package Includes Light, LDM 350/3, and 4 Meter Stainless Steel Cable 	<b>\$1100</b>	<b>365 + \$100</b> UV 365nm <b>395 + \$100</b> UV 395nm <b>470 + \$0</b> Blue <b>530 + \$0</b> Green <b>630 + \$0</b> Red <b>850 + 100</b> Infrared <b>WHI + \$0</b> White	<b>12 + \$0</b> 12 Degree <b>16 + \$0</b> 16 Frosted <b>23 + \$0</b> 23 Frosted <b>30 + \$0</b> 30 Frosted <b>39 + \$0</b> 39 Frosted <b>50 + \$0</b> 50 Degree <b>F + \$0</b> Wide Angle <b>R + \$0</b> Reflector 90 <b>L + \$0</b> Line	<b>SD + \$0</b> Standard <b>CC + \$0</b> Clear Cover <b>WD + \$0</b> White <b>UVCC + \$0</b> UV Clear Cover	<b>LDM350/3+ \$0</b> 350mA Driver <b>A + \$85</b> ALDM Driver <b>V + \$85</b> VLDM Driver <b>RV + \$100</b> RVLDM Driver	<b>WMC4 + \$0</b> 4 meter <b>WMC8 + \$55</b> 8 meter <b>WMC15 + \$75</b> 15 meter <b>WMC30 *</b> 30 meter
Dimensions: D 4.5" CC 14.13" H 1.25" Wgt .152 lbs				(*) Call for pricing		

Back Lights  
Diffused Axial  
Dome Lights  
Linear Lights  
Oxy Lights  
Ring Lights  
Spot Lights  
Washdown Lights  
Controllers & Cables

Back Lights  
Diffused Axial  
Dome Lights  
Linear Lights  
Oxy Lights  
Ring Lights  
Spot Lights  
Washdown Lights  
Controllers & Cables

### Monster-Series Washdown Ring & Dome Lights

Features:

- External driver/controller included
- HS (High Speed) Strobe Technology
- High Power LED's (24 VDC)
- M12 connector for quick disconnect
- Available in 8 colors and Infrared
- Available in 1 size
- IP68 & FDA Compliant
- Self draining dome design
- 3 Year Warranty\* - 100,000 hours

Caution –

The supplied LDM adapter must be used for both continuous or strobe operations! Do not connect the fixture directly to 24VDC! Operating the fixture without the supplied LDM adapter will result in premature

To Order, Specify;

1 Base Part Number	<b>WMRL8.5</b>	<b>\$2000</b>
2 LED Color	<b>470</b>	<b>\$0</b>
3 Lens	<b>16</b>	<b>\$0</b>
4 Diffuser	<b>CC</b>	<b>\$0</b>
5 Driver Option	<b>V</b>	<b>\$85</b>
6 Cable Option	<b>WMC4</b>	<b>\$0</b>

1 Base Part Number	List Price	2 LED	3 Lens	4 Diffuser	5 Driver	6 Cable
<b>WMRL8.5</b> 8.5" Ring Light LED - Package Includes Light, LDM 700, and 4 Meter Cable 	<b>\$2500</b>	<b>470 + \$0</b> Blue <b>530 + \$0</b> Green <b>630 + \$0</b> Red <b>850 + \$50</b> Infrared <b>WHI + \$0</b> White <b>NWH + \$0</b> Neutral White	<b>16 + \$0</b> 16 Frosted <b>23 + \$0</b> 23 Frosted <b>39 + \$0</b> 39 Frosted	<b>CC + \$0</b> Clear Cover <b>WD + \$0</b> White	<b>LDM700+ \$0</b> 700mA Driver <b>A + \$85</b> ALDM Driver <b>V + \$85</b> VLDM Driver <b>RV + \$100</b> RVLDM Driver	<b>WMC4 + \$0</b> 4 meter <b>WMC8 + \$55</b> 8 meter <b>WMC15 + \$75</b> 15 meter <b>WMC30 *</b> 30 meter

Dimensions: D 12" CC 37.68" H 1.45" Wgt 6.85 lbs

(\* Call for pricing)

<b>WMDL7</b> 7" Dome Light LED - Package Includes Light, LDM 700 and 4 Meter Cable 	<b>\$2750</b>	<b>470 + \$0</b> Blue <b>530 + \$0</b> Green <b>630 + \$0</b> Red <b>850 + \$50</b> Infrared <b>WHI + \$0</b> White <b>NWH + \$0</b> Neutral White	No Options	No Options	<b>LDM700+ \$0</b> 700mA Driver <b>A + \$85</b> ALDM Driver <b>V + \$85</b> VLDM Driver <b>RV + \$100</b> RVLDM Driver	<b>WMC4 + \$0</b> 4 meter <b>WMC8 + \$55</b> 8 meter <b>WMC15 + \$75</b> 15 meter <b>WMC30 *</b> 30 meter
--	---------------	---	------------	------------	---	--

Dimensions: D 12" CC 37.68" H 1.45" Wgt 7.9 lbs

(\* Call for pricing)

This page is intentionally blank

### LDM Series Controllers/Drivers

The LED Driver Module (LDM) is a current regulating DIN rail mounted adapter for our Monster Light Series products. Every Monster Light includes the correct LDM and 4 meter cable for the product. The LDM connects to industry standard 24VDC power and is used for strobe or continuous operation. The LDM Adapter has both PNP and NPN strobe inputs with a 3 microsecond response time. The strobe inputs are pulse width duration so they are on for the length of the supplied pulse. Since the LDM's release in 2002 through today and after 8 revision improvements, the LDM has proven itself to be superior in reliability, repeatability and quality.

**To Order, Specify;**

**1 Base Part Number**

Example:

**LDM350/1**  
**\$275**

### Service Parts

Controllers/Drivers	77-81
Cables	82-83

1 Base Part Number	Description	List Price
LDM350/1	Standard LED Driver Module	\$275
LDM350/2	Standard LED Driver Module	\$275
LDM350/3	Standard LED Driver Module	\$275
LDM700	Standard LED Driver Module	\$275
LDM1050	Standard LED Driver Module	\$275
LDM1400	Standard LED Driver Module	\$275
LDM1750	Standard LED Driver Module	\$275
LDM2100	Standard LED Driver Module	\$275
LDM2800	Standard LED Driver Module	\$275
LDM3500	Standard LED Driver Module	\$275
LDM4900	Standard LED Driver Module	\$275



**Standard Dimensions**

W .89"  
L 4.5"  
H 3.9"  
Wt .25lbs

## ALDM Series Controllers/Drivers

The Analog LED Driver Module (ALDM) is a current regulating DIN rail mounted adapter for our Monster Light Series products. Unlike the LDM the ALDM also has a 0-10VDC input for intensity control. Every Monster Light can be ordered with the optional ALDM Adapter for a minimal up charge. The ALDM connects to industry standard 24VDC power and is used for strobe or continuous operation. The ALDM Adapter has both PNP and NPN strobe inputs with a 3 microsecond response time. The strobe inputs are pulse width duration so they are on for the length of the supplied pulse. The ALDM is based on the same time tested technology as our LDM Adapter.

**To Order, Specify;**

① Base Part Number

Example: **ALDM350/1**  
**\$325**

① Base Part Number	Description	List Price
ALDM350/1	0-10VDC intensity control DIN rail mounted Analog LED Driver Module	\$325
ALDM350/2	0-10VDC intensity control DIN rail mounted Analog LED Driver Module	\$325
ALDM350/3	0-10VDC intensity control DIN rail mounted Analog LED Driver Module	\$325
ALDM700	0-10VDC intensity control DIN rail mounted Analog LED Driver Module	\$325
ALDM1050	0-10VDC intensity control DIN rail mounted Analog LED Driver Module	\$325
ALDM1400	0-10VDC intensity control DIN rail mounted Analog LED Driver Module	\$325
ALDM1750	0-10VDC intensity control DIN rail mounted Analog LED Driver Module	\$325
ALDM2100	0-10VDC intensity control DIN rail mounted Analog LED Driver Module	\$325
ALDM2800	0-10VDC intensity control DIN rail mounted Analog LED Driver Module	\$325
ALDM3500	0-10VDC intensity control DIN rail mounted Analog LED Driver Module	\$325



**Standard Dimensions**  
**W** .89"  
**D** 4.5"  
**H** 3.9"  
**Wt** .25lbs

## VLDM Series Controllers/Drivers

The Variable LED Driver Module (VLDM) is a current regulating DIN rail mounted adapter for our Monster Light Series products. Unlike the LDM the VLDM gives the end user the ability to adjust the light intensity via manual potentiometer. Every Monster Light can be ordered with the optional VLDM Adapter for a minimal up charge. The VLDM connects to industry standard 24VDC power and is used for strobe or continuous operation. The VLDM Adapter has both PNP and NPN strobe inputs with a 3 microsecond response time. The strobe inputs are pulse width duration so they are on for the length of the supplied pulse. The VLDM is based on the same time tested technology as our LDM Adapter.

**To Order, Specify;**

① Base Part Number

Example: **VLDM350/1**  
**\$325**

① Base Part Number	Description	List Price
VLDM350/1	DIN rail mounted Variable Intensity Control LED Driver Module	\$325
VLDM350/2	DIN rail mounted Variable Intensity Control LED Driver Module	\$325
VLDM350/3	DIN rail mounted Variable Intensity Control LED Driver Module	\$325
VLDM700	DIN rail mounted Variable Intensity Control LED Driver Module	\$325
VLDM1050	DIN rail mounted Variable Intensity Control LED Driver Module	\$325
VLDM1400	DIN rail mounted Variable Intensity Control LED Driver Module	\$325
VLDM1750	DIN rail mounted Variable Intensity Control LED Driver Module	\$325
VLDM2100	DIN rail mounted Variable Intensity Control LED Driver Module	\$325
VLDM2800	DIN rail mounted Variable Intensity Control LED Driver Module	\$325
VLDM3500	DIN rail mounted Variable Intensity Control LED Driver Module	\$325



**Standard Dimensions**  
**W** .89"  
**L** 4.5"  
**H** 3.9"  
**Wt** .25lbs

## RLDM Series Controllers/Drivers

The Remote Variable LED Driver Module (RVLDM) is a current regulating DIN rail mounted adapter for our Monster Light Series products. Unlike the LDM the RVLDM gives the end user the ability to adjust the light intensity via manual remote potentiometer. Every Monster Light can be ordered with the optional RVLDM Adapter for a minimal up charge. The RVLDM connects to industry standard 24VDC power and is used for strobe or continuous operation. The RVLDM Adapter has both PNP and NPN strobe inputs with a 3 microsecond response time. The strobe inputs are pulse width duration so they are on for the length of the supplied pulse. The RVLDM is based on the same time tested technology as our LDM.

**To Order, Specify;**

① Base Part Number

Example: **RVLDM350/1**  
**\$375**

① Base Part Number	Description	List Price
RVLDM350/1	DIN rail mounted Remote Variable Intensity Control LED Driver Module	\$375
RVLDM350/2	DIN rail mounted Remote Variable Intensity Control LED Driver Module	\$375
RVLDM350/3	DIN rail mounted Remote Variable Intensity Control LED Driver Module	\$375
RVLDM700	DIN rail mounted Remote Variable Intensity Control LED Driver Module	\$375
RVLDM1050	DIN rail mounted Remote Variable Intensity Control LED Driver Module	\$375
RVLDM1400	DIN rail mounted Remote Variable Intensity Control LED Driver Module	\$375
RVLDM1750	DIN rail mounted Remote Variable Intensity Control LED Driver Module	\$375
RVLDM2100	DIN rail mounted Remote Variable Intensity Control LED Driver Module	\$375
RVLDM2800	DIN rail mounted Remote Variable Intensity Control LED Driver Module	\$375
RVLDM3500	DIN rail mounted Remote Variable Intensity Control LED Driver Module	\$375



**Standard Dimensions**  
**W** .89"  
**D** 4.5"  
**H** 3.89"  
**Wt** .25lbs

## ILD Series Controllers/Drivers

The ILD (In Line Driver) has a current-regulating output in a compact size. Its current output is capable of running LEDs at a higher current level (1.3A/LED) for 500µs, then automatically dropping to the standard current level (350mA/LED) for the duration of the strobe input pulse. Ideal for users who don't have extra room in the DIN rail cabinet or just need a higher current strobe for high-speed applications. It also has intensity control via a built-in potentiometer or 0 - 10VDC that allows for control of the burst and constant current. Input is a standard M12 5-pin connector. The output is a feed-through header with a mating "Push-X-connection" connector standard. Other options are available for quote.

**To Order, Specify;**

① Base Part Number

Example: **ILD70026**  
**\$250**

① Base Part Number	Description	List Price
ILD35013	In Line Driver 350mA continuous 1.3A burst	\$250
ILD70026	In Line Driver 700mA continuous 2.6A burst	\$250
ILD105037	In Line Driver 1050mA continuous 3.7A burst	\$275
ILD140050	In Line Driver 1400mA continuous 5.0A burst	\$275



**Standard Dimensions**  
**W** 1.90"  
**L** 1.54"  
 (3.00" including connectors)  
**H** 1.22"

**Features**

- \* Industry standard 24VDC power
- \* Compact Size
- \* Auto Burst 3.5x Technology
- \* PNP and NPN strobe inputs
- \* 0 - 10 VDC intensity control
- \* Potentiometer Intensity control
- \* M12 connector for quick disconnect
- \* Thermal Protection to reduce downtime

## Cables

Replacement cables can be purchased and while many are in stock specialty cables (high flex or longer lengths) may have longer lead times.

**To Order, Specify;**

① Base Part Number

Example:

**CTL-.5**  
**\$35**

① Base Part Number	Description	List Price	
CTL-.5	Camera to Light Cognex .5 Meter	\$35	.2lbs
CTL-1	Camera to Light Cognex 1 Meter	\$35	.4lbs
CTL-2	Camera to Light Cognex 2 Meter	\$40	.5lbs
EC3	Standard Regular 3 Meter	\$50	.6lbs
EC5	Standard Regular 5 Meter	\$60	1.03lbs
MC4	Monster Regular 4 Meter	\$40	.5lbs
MC8	Monster Regular 8 Meter	\$60	.93lbs
MC15	Monster Regular 15 Meter	\$100	1.75lbs
MC30	Monster Regular 30 Meter	*Call for pricing	3.43lbs
MCHF4	Monster High Flex 4 Meter	\$75	.37lbs
MCHF8	Monster High Flex 8 Meter	\$100	.73lbs
MCHF15	Monster High Flex 15 Meter	*Call for pricing	1.34lbs
MCHF30	Monster High Flex 30 Meter	*Call for pricing	1.34lbs
SC4	Standard Regular 4 Meter	\$40	.35lbs
SC8	Standard Regular 8 Meter	\$90	.79lbs
SC15	Standard Regular 15 Meter	\$125	1.23lbs
SC30	Standard Regular 30 Meter	*Call for pricing	2.6lbs
SCHF4	Standard High Flex 4 Meter	\$75	.37lbs
SCHF8	Standard High Flex 8 Meter	\$100	.73lbs
SCHF15	Standard High Flex 15 Meter	\$200	1.34lbs
SCHF30	Standard High Flex 15 Meter	*Call for pricing	2.6815
WMC4	Monster Wash Down 4 Meter	\$50	.48lbs
WMC8	Monster Wash Down 8 Meter	\$95	.92lbs
WMC15	Monster Wash Down 15 Meter	\$115	1.7lbs
WMC30	Monster Wash Down 30 Meter	*Call for pricing	3.2lbs
WSC4	Standard Wash Down 4 Meter	\$40	.35lbs
WSC8	Standard Wash Down 8 Meter	\$100	.77lbs
WSC15	Standard Wash Down 15 Meter	\$120	1.39lbs
WSC30	Standard Wash Down 30 Meter	*Call for pricing	1.39lbs

## Cables for Monster Linear Lights 69" and 103.5"

**To Order, Specify;**

① Base Part Number

Example:

**MC4-HO/6**  
**\$175**

① Base Part Number	Description	List Price
MC4-HO/6	Monster Cable High Output 4 meter	\$175
MC8-HO/6	Monster Cable High Output 8 meter	\$250
MC15-HO/6	Monster Cable High Output 15 meter	\$300
MC30-HO/6	Monster Cable High Output 30 meter	*Call for pricing
MCHF4-HO/6	Monster High Flex High Output 4 meter cable	*Call for pricing
MCHF8-HO/6	Monster High Flex High Output 8 meter cable	*Call for pricing
MCHF15-HO/6	Monster High Flex High Output 15 meter cable	*Call for pricing
MCHF30-HO/6	Monster High Flex High Output 30 meter cable	*Call for pricing

**Part Number ..Page #**

ALDM350/1 .....78  
 ALDM350/2 .....78  
 ALDM350/3 .....78  
 ALDM700 .....78  
 ALDM1050 .....78  
 ALDM1400 .....78  
 ALDM1750 .....78  
 ALDM2100 .....78  
 ALDM2800 .....78  
 ALDM3500 .....78  
 SBL14.....6  
 SBL18.....6  
 SBL22.....6  
 SBL24.....7  
 SBL26.....7  
 SBL34.....8  
 SBL36.....8  
 SBL38.....8  
 SBL44.....9  
 SBL46.....9  
 SBL48.....10  
 SBL56.....10  
 SBL66.....11  
 SBL68.....11  
 SBL88.....12  
 SBL210.....7  
 SBL312.....9  
 SBL414.....10  
 SBL610.....11  
 SBL612.....12  
 SBL812.....12  
 SBL1010.....13  
 SBL1212.....13  
 CTL-1.....82  
 CTL-2.....82  
 CTL-.5.....82  
 DL180-X.....24  
 DL180-XX.....24  
 DL180-XXX.....24  
 DL180-XXXX.....25  
 DLD85-X.....26  
 DLD85-XX.....27  
 DLD180-X.....27  
 DLD180-XX.....27  
 DLD180-XXX.....28  
 DLD180-XXXX.....28

**Part Number ..Page #**

EC3 .....82  
 EC5.....82  
 EL150.....37  
 EL300.....37  
 EL2150.....37  
 ES40.....63  
 ILD35013.....81  
 ILD70026.....81  
 ILD105037.....81  
 ILD140050.....81  
 LA14.....33  
 LA18.....33  
 LA24.....35  
 LA112.....34  
 LA116.....34  
 LA124.....34  
 LDM350/1.....77  
 LDM350/2.....77  
 LDM350/3.....77  
 LDM700.....77  
 LDM1050.....77  
 LDM1400.....77  
 LDM1750.....77  
 LDM2100.....77  
 LDM2800.....77  
 LDM3500.....77  
 LDM4900.....77  
 MBL22.....15  
 MBL24.....15  
 MBL44.....15  
 MBL46.....16  
 MBL48.....16  
 MC4.....82  
 MC4-HO/6.....83  
 MC8.....82  
 MC8-HO/6.....83  
 MC15.....82  
 MC15-HO/6.....83  
 MC30.....82  
 MC30-HO/6.....83  
 MCHF4.....82  
 MCHF4-HO/6.....83  
 MCHF8.....82  
 MCHF8-HO/6.....83  
 MCHF15.....82  
 MCHF15-HO/6.....83  
 MCHF30.....82  
 MCHF30-HO/6.....83

**Part Number ..Page #**

MDA2.....19  
 MDA2-Bracket.....20  
 MDA4.....19  
 MDL7.25.....29  
 MDL12.25.....29  
 MDL18.25.....30  
 MDL29.25.....30  
 MLL12.....39  
 MLL14.....39  
 MLL16.....39  
 MLL22.....43  
 MLL24.....43  
 MLL26.....44  
 MLL44.....44  
 MLL46.....44  
 MLL48.....45  
 MLL111.5.....40  
 MLL117.25.....40  
 MLL123.....41  
 MLL128.75.....41  
 MLL134.5.....41  
 MLL146.....42  
 MLL157.5.....42  
 MLL169.....43  
 MLL180.5.....43  
 MLLD16.....47  
 MLLD111.5.....47  
 MLLD117.25.....48  
 MLLD123.....48  
 MRL2.5.....57  
 MRL3.5.....57  
 MRL5.5.....57  
 MRL8.5.....58  
 MRL13.5.....58  
 MRL19.5.....59  
 MRL30.5.....59  
 MRLD3.5.....60  
 MRLD5.5.....60  
 MSP1.25.....65  
 MSP3.25.....65  
 MSP5.5.....65  
 OL66.....51  
 OL1212.....51  
 RL4.....54  
 RL70.....54  
 RL/DF4.....55  
 RL/DF8.....55

**Part Number ..Page #**

RVLDM350/1.....80  
 RVLDM350/2.....80  
 RVLDM350/3.....80  
 RVLDM700.....80  
 RVLDM1050.....80  
 RVLDM1400.....80  
 RVLDM1750.....80  
 RVLDM2100.....80  
 RVLDM2800.....80  
 RVLDM3500.....80  
 SC4.....82  
 SC8.....82  
 SC15.....82  
 SC30.....82  
 SCHF4.....82  
 SCHF8.....82  
 SCHF15.....82  
 VLDM350/1.....79  
 VLDM350/2.....79  
 VLDM350/3.....79  
 VLDM700.....79  
 VLDM1050.....79  
 VLDM1400.....79  
 VLDM1750.....79  
 VLDM2100.....79  
 VLDM2800.....79  
 VLDM3500.....79  
 WBL44.....69  
 WBL48.....70  
 WBL812.....70  
 WMC4.....82  
 WMC8.....82  
 WMC15.....82  
 WMC30.....82  
 WMDL7.....74  
 WMML16.....71  
 WMML111.5.....72  
 WMML117.25.....72  
 WMML123.....72  
 WMRL8.5.....74  
 WMSP1.25.....73  
 WMSP3.25.....73  
 WRL4.....70  
 WSC4.....82  
 WSC8.....82  
 WSC15.....82  
 WSC30.....82  
 XL300.....49  
 XL2150.....49  
 XS40.....66

