

4

3

2

1

TOP VIEW

BOTTOM VIEW

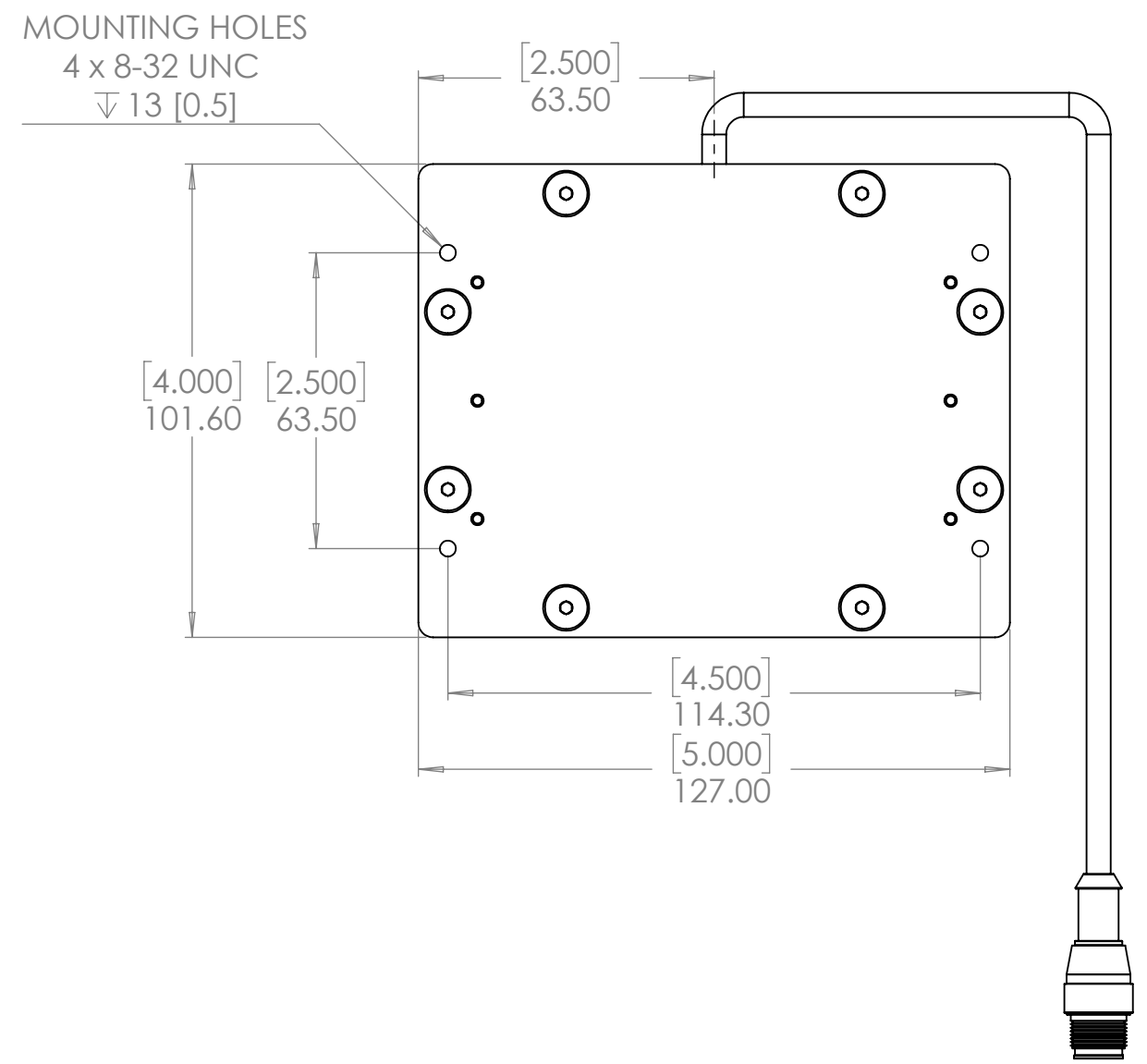
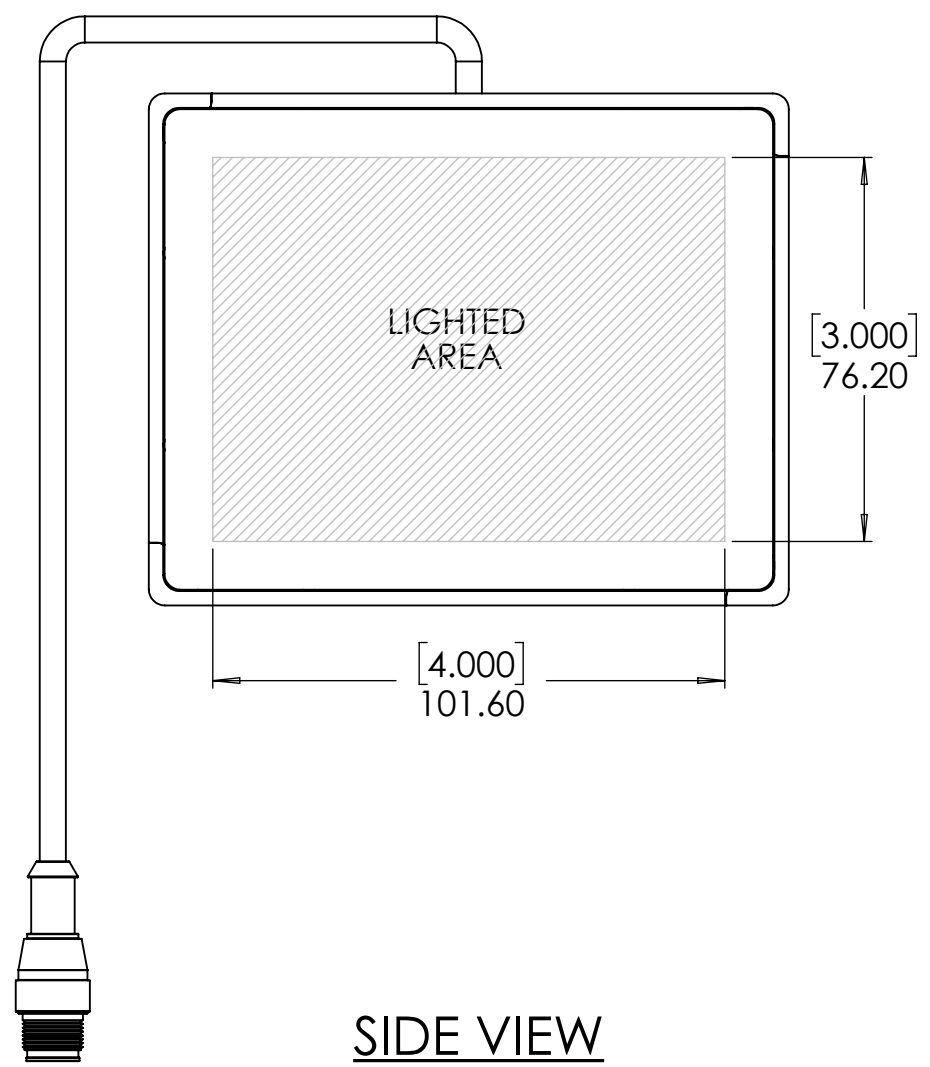

SIDE VIEW

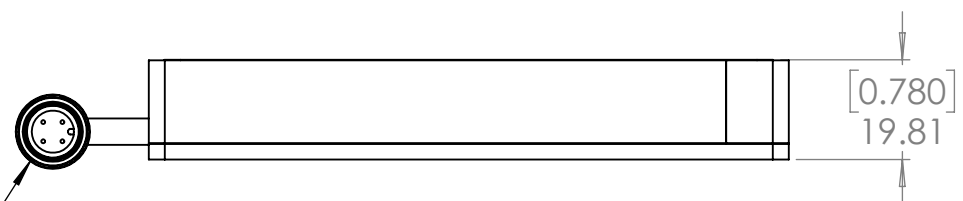

STANDARD EUROFAST M12 4-PIN MALE CONNECTOR

1	4	PIN 1 - BROWN / +24VDC
2	3	PIN 2 - WHITE / N/C
		PIN 3 - BLUE / +24VDC RTN
		PIN 4 - BLACK / STROBE-CONTINUOUS

UNLESS OTHERWISE SPECIFIED:	NAME	DATE
DIMENSIONS ARE IN mm [INCH]	DRAWN	DJH 04/23/21
TOLERANCES:	CHECKED	- -
ANGULAR: MACH ± BEND ±	ENG APPR.	
ONE PLACE DECIMAL ±1.0	MFG APPR.	
TWO PLACE DECIMAL ±0.5	Q.A.	
THREE PLACE DECIMAL ±0.25	COMMENTS:	
INTERPRET GEOMETRIC TOLERANCING PER:		
MATERIAL		
FINISH		
DO NOT SCALE DRAWING		

PROPRIETARY AND CONFIDENTIAL
 THE INFORMATION CONTAINED IN THIS DRAWING IS THE SOLE PROPERTY OF SPECTRUM ILLUMINATION INC. ANY REPRODUCTION IN PART OR AS A WHOLE WITHOUT THE WRITTEN PERMISSION OF SPECTRUM ILLUMINATION INC IS PROHIBITED.

SPECTRUM ILLUMINATION
 5114 INDUSTRIAL PARK RD.
 MONTAGUE, MI 49437

Description:
 3" x 4" Conveyor Backlight

SIZE	DWG. NO.	REV
B	EBL34-XXX	A
SCALE: 1:1.5 WEIGHT:		SHEET 1 OF 1

4

3

2

1

B

B

A

A