

TOP VIEW

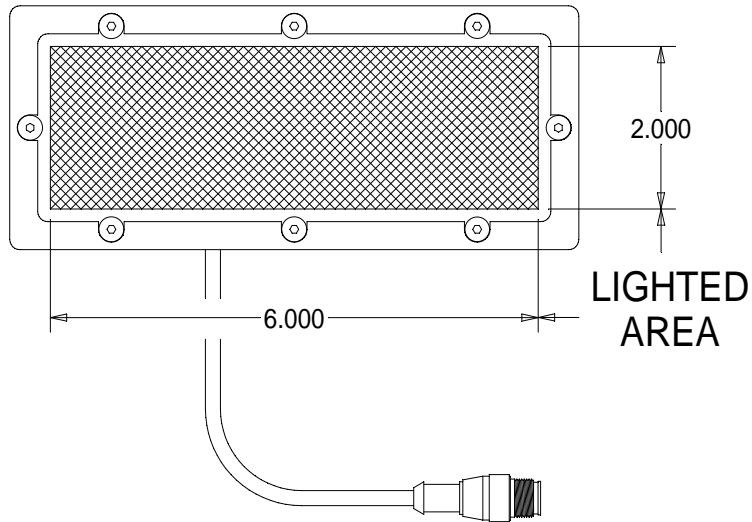

BOTTOM VIEW

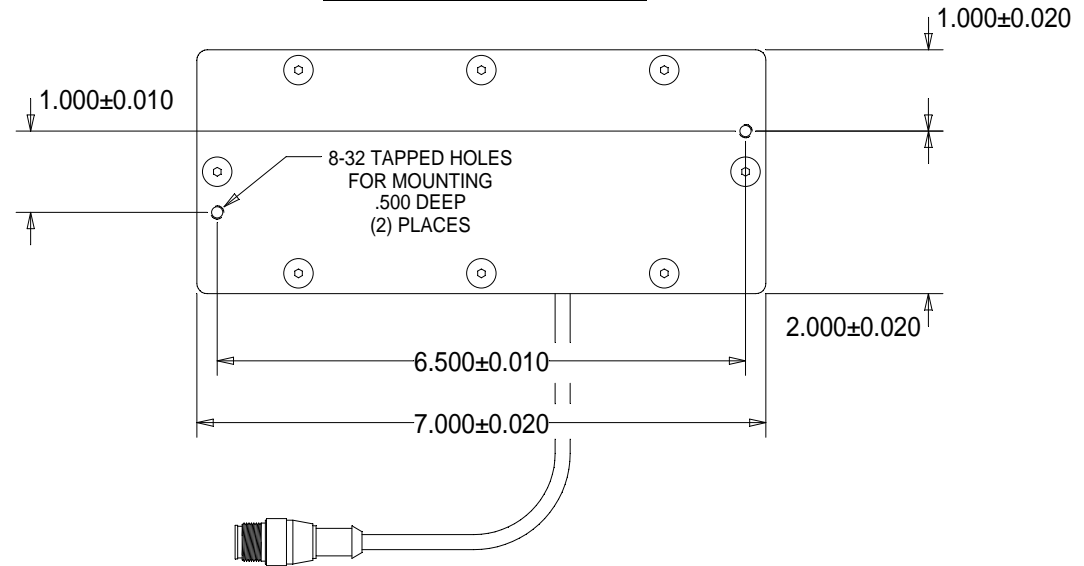

SIDE VIEW

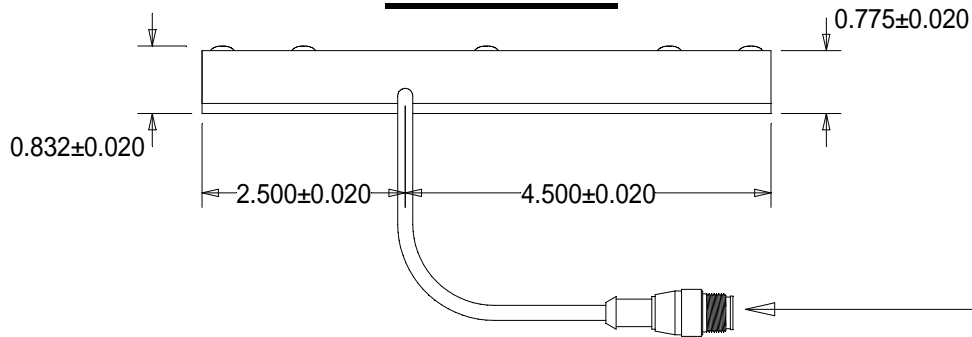

STANDARD EUROFAST 4-PIN (MALE) CONNECTOR

PIN 1 (+24VDC / BROWN)
PIN 3 (GROUND / BLUE)
PIN 4 (+24VDC / BLACK) STROBE/CONT.

BL26 MOUNT SPECIFICATIONS