

TOP VIEW

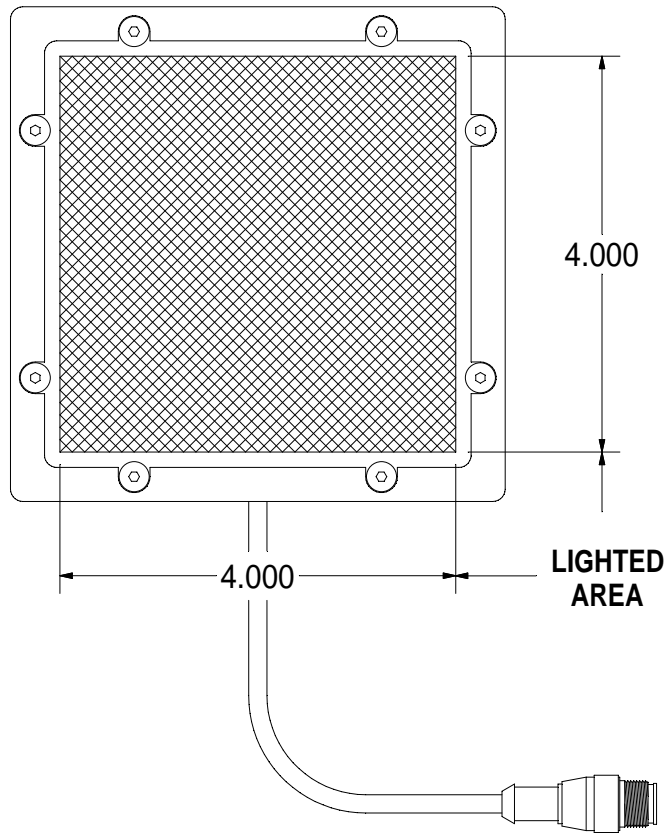

BOTTOM VIEW

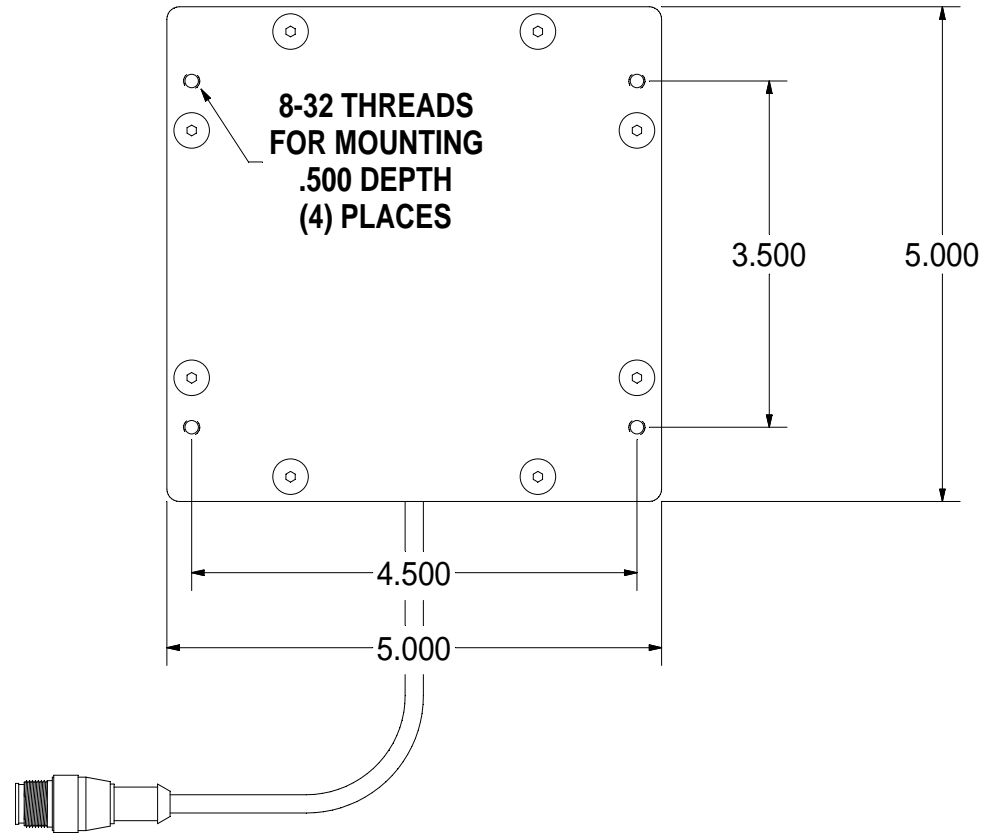

SIDE VIEW

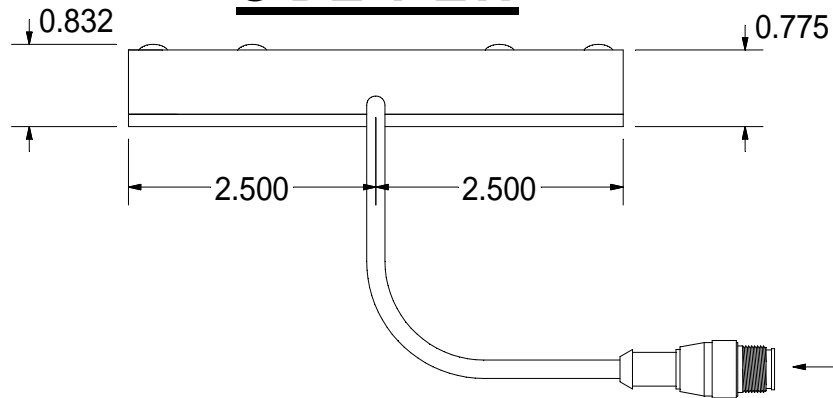

STANDARD EUROFAST 4-PIN (MALE) CONNECTOR

PIN 1 (+24VDC / BROWN)

PIN 3 (GROUND / BLUE)

PIN 4 (+24VDC / BLACK) STROBE/CONT.

BL44 MOUNT SPECIFICATIONS